

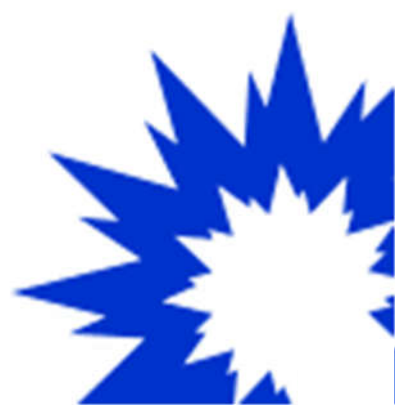

## Forage

Outils hors trou



R22 p. 4

R23 p. 6

R25 p. 8

R28 p. 12

R32 p. 16

GR34 p. 22

R35 p. 24

R38 p. 28

ST58 p. 30

ST68 p. 32

T35 p. 34

T38 p. 36

T45 p. 40

T51 p. 44

T60 p. 48

GT60 p. 52



## Plus de 50 ans d'expérience

Notre partenaire en Pologne opère sur le marché international depuis 1974, dans la fabrication d'outils pour le forage pour les mines souterraines et à ciel ouvert, les carrières et les chantiers de construction.

Il utilise exclusivement des matières premières provenant de fournisseurs certifiés dans ses installations de production innovantes de haute technologie, garantissant une haute qualité pour ses outils de forage et une cémentation complète de ses tiges de forage.

La production est régulièrement contrôlée par le laboratoire recherche et développement interne. Les boutons sont également fabriqués dans l'usine, par frittage en étuve sous vide. Le tout assure une qualité optimale de fabrication.

Toutes les étapes de fabrication étant menée en interne, notre partenaire peut réaliser, sous réserve de possibilité technique, des prototypes à la demande.

*Nomenclature boutons : R – sphériques  
S – semi-balistiques  
C – coniques (drop center T35 à GT60 uniquement)  
Taillants aléseurs : Nous consulter*



## Tiges :

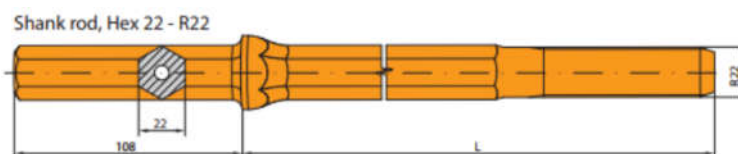

Hex (mm)	Filetage	Longueur (mm)	Poids (kg)	Référence
22	R22	610	2,2	25117061
22	R22	760	2,6	25117076
22	R22	1600	5,2	25117160
22	R22	1830	5,9	25117183
22	R22	2435	7,7	25117243
22	R22	3050	9,6	25117305
22	R22	3660	11,5	25117366

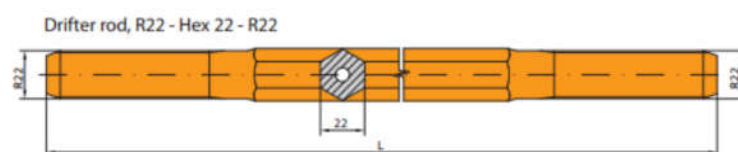

Hex (mm)	Filetage	Longueur (mm)	Poids (kg)	Référence
22	R22/R22	610	1,9	24717061
22	R22/R22	760	2,3	24717076
22	R22/R22	1600	4,9	24717160
22	R22/R22	1830	5,6	24717183
22	R22/R22	2435	7,4	24717243
22	R22/R22	3050	9,3	24717305
22	R22/R22	3660	11,2	24717366

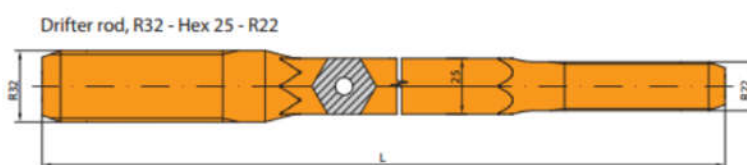

Hex (mm)	Filetage	Longueur (mm)	Poids (kg)	Référence
25	R32/R22	610	2,4	20417061
25	R32/R22	760	3,0	20417076
25	R32/R22	1600	6,2	20417160
25	R32/R22	1830	7,1	20417183
25	R32/R22	2435	9,4	20417243
25	R32/R22	3050	11,8	20417305
25	R32/R22	3660	14,2	20417366

## Manchons :



D (mm)	Filetage	L (mm)	Poids (kg)	Référence
32	R22/R22	140	0,6	3971700



## Taillants :



D45

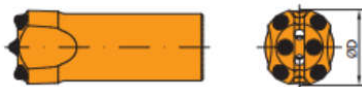

D46

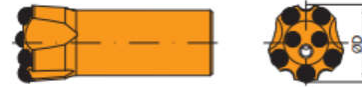

D47

Diamètre (mm)	Trous de soufflage (mm)		Boutons (mm)		Poids (kg)	Référence
	Latéral (q x d)	Face (q x d)	Latéral (q x d)	Face (q x d)		
30	1x5	1x5	3x7	2x7	0,2	D45030R2205
32	1x5	1x5	3x8	2x7	0,3	D45032R2205
33	1x5	1x5	3x8	2x7	0,3	D45033R2205
35	1x5	1x5	3x9	2x7	0,4	D45035R2205
32	-	2x5	4x7	2x7	0,3	D46032R2205
33	-	2x5	4x7	2x7	0,3	D46033R2205
35	-	2x5	4x8	2x7	0,4	D46035R2205
37	-	2x5	4x8	2x7	0,4	D46037R2205
38	-	2x5	4x9	2x7	0,5	D46038R2205
41	-	2x5	4x9	2x8	0,6	D46041R2205
32	1x5	1x4	5x7	2x7	0,4	D47032R2205
33	1x5	1x4	5x7	2x7	0,4	D47033R2205
35	1x6	1x5	5x8	2x7	0,4	D47035R2205
37	1x6	1x5	5x9	2x7	0,5	D47037R2205
38	1x6	1x5	5x9	2x7	0,5	D47038R2205
41	1x6	1x5	5x9	2x8	0,6	D47041R2205



## Tiges :

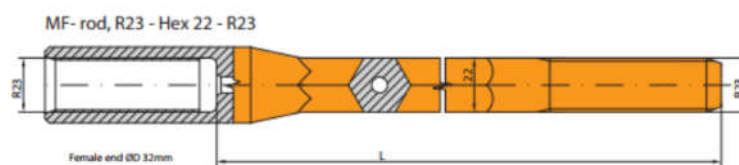

R23

Hex (mm)	Filetage	Longueur (mm)	Poids (kg)	Référence
22	R23/R23	915	3,2	11H22R23R23091
22	R23/R23	1220	4,1	11H22R23R23122
22	R23/R23	1525	5,1	11H22R23R23152
22	R23/R23	1830	6,0	11H22R23R23183
22	R23/R23	2435	7,8	11H22R23R23243
22	R23/R23	3050	9,7	11H22R23R23305
22	R23/R23	3660	11,6	11H22R23R23366
22	R23/R23	4305	13,5	11H22R23R23430

## Taillants :



D47

Diamètre (mm)	Trous de soufflage (mm)		Boutons (mm)		Poids (kg)	Référence
	Latéral (q x d)	Face (q x d)	Latéral (q x d)	Face (q x d)		
33	1x5	1x4	5x7	2x7	0,3	D47033R2305
35	1x6	1x5	5x8	2x7	0,3	D47035R2305
38	1x6	1x5	5x9	2x7	0,4	D47038R2305
41	1x6	1x5	5x9	2x8	0,6	D47041R2305



## Tiges :

Shank rod, Hex 22 - R25

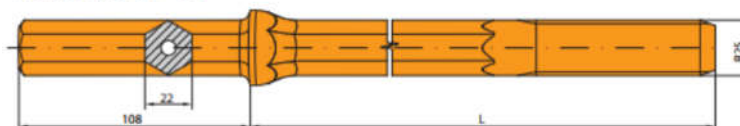

Hex (mm)	Filetage	Longueur (mm)	Poids (kg)	Référence
22	R25	610	2,3	25111061
22	R25	760	2,7	25111076
22	R25	1000	3,5	25111100
22	R25	1200	4,1	25111120
22	R25	1600	5,3	25111160
22	R25	1830	6,0	25111183
22	R25	2400	7,7	25111240
22	R25	3200	10,2	25111320
22	R25	3660	11,6	25111366
22	R25	4000	12,6	25111400

Shank rod, Hex 25 - R25

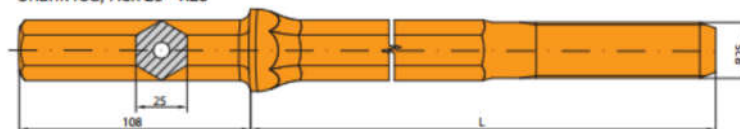

Hex (mm)	Filetage	Longueur (mm)	Poids (kg)	Référence
25	R25	610	2,9	25311061
25	R25	760	3,5	25311076
25	R25	1000	4,4	25311100
25	R25	1200	5,1	25311120
25	R25	1600	6,7	25311160
25	R25	1830	7,6	25311183
25	R25	2400	9,8	25311240
25	R25	3200	12,9	25311320
25	R25	3660	14,3	25311366
25	R25	4000	16,2	25311400

Shank rod, Hex 25 - R25

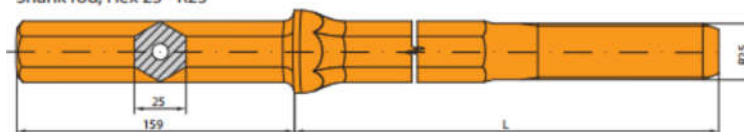

Hex (mm)	Filetage	Longueur (mm)	Poids (kg)	Référence
25	R25	610	3,1	25511061
25	R25	760	3,7	25511076
25	R25	1000	4,6	25511100
25	R25	1200	5,3	25511120
25	R25	1600	6,9	25511160
25	R25	1830	7,8	25511183
25	R25	2400	10,0	25511240
25	R25	3200	13,1	25511320
25	R25	3660	14,5	25511366
25	R25	4000	16,4	25511400

R25



## Tiges :

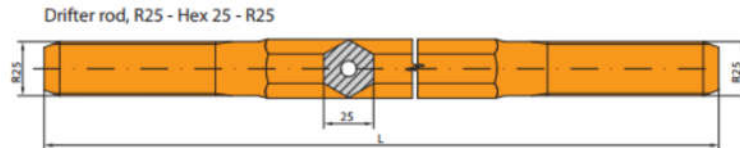

Hex (mm)	Filetage	Longueur (mm)	Poids (kg)	Référence
25	R25/R25	610	2,0	20111061
25	R25/R25	915	3,2	20111091
25	R25/R25	1220	4,3	20111122
25	R25/R25	1525	5,4	20111152
25	R25/R25	1830	6,5	20111183
25	R25/R25	2435	8,7	20111243
25	R25/R25	3050	10,8	20111305
25	R25/R25	3660	13,8	20111366

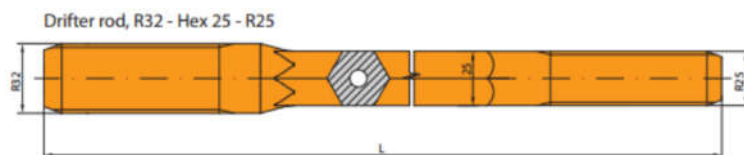

Hex (mm)	Filetage	Longueur (mm)	Poids (kg)	Référence
25	R32/R25	610	2,5	20114061
25	R32/R25	915	3,7	20114091
25	R32/R25	1220	4,8	20114122
25	R32/R25	1525	6,0	20114152
25	R32/R25	1830	7,2	20114183
25	R32/R25	2435	9,5	20114243
25	R32/R25	3050	11,9	20114305
25	R32/R25	3660	14,3	20114366
25	R32/R25	4000	15,6	20114400

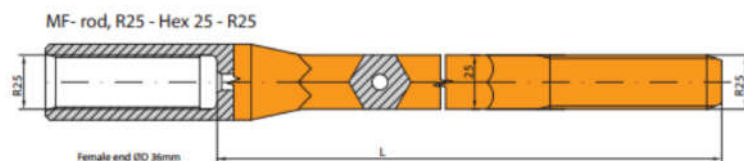

Hex (mm)	Filetage	Longueur (mm)	Poids (kg)	Référence
25	R25/R25	610	2,8	26717061
25	R25/R25	915	4,0	26717091
25	R25/R25	1220	5,1	26717122
25	R25/R25	1525	6,3	26717152
25	R25/R25	1830	7,5	26717183
25	R25/R25	2435	9,9	26717243
25	R25/R25	3050	12,2	26717305
25	R25/R25	3660	14,6	26717366



## Tiges :

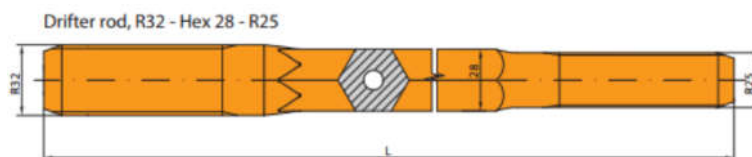

Hex (mm)	Filetage	Longueur (mm)	Poids (kg)	Référence
28	R32/R25	610	3,0	28022061
28	R32/R25	915	4,5	28022091
28	R32/R25	1220	6,1	28022122
28	R32/R25	1525	7,6	28022152
28	R32/R25	1830	9,1	28022183
28	R32/R25	2435	12,2	28022243
28	R32/R25	3050	15,3	28022305
28	R32/R25	3660	18,4	28022366
28	R32/R25	4000	20,1	28022400

R25

## Manchons :

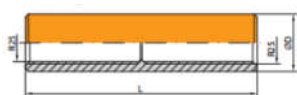

D (mm)	Filetage	L (mm)	Poids (kg)	Référence
35	R25/R25	140	0,7	3911100



D (mm)	Filetage	L (mm)	Poids (kg)	Référence
44	R32/R25	150	1,2	3911400

## Taillants :

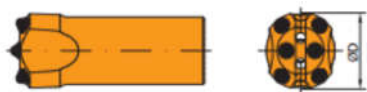

D46

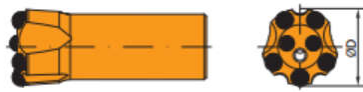

D47

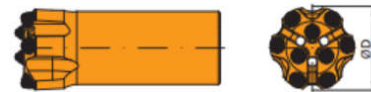

D49

Diamètre (mm)	Trous de soufflage (mm)		Boutons (mm)		Poids (kg)	Référence
	Latéral (q x d)	Face (q x d)	Latéral (q x d)	Face (q x d)		
33	-	2x5	4x7	2x7	0,3	D46033R2505
35	-	2x5	4x8	2x7	0,4	D46035R2505
37	-	2x5	4x8	2x7	0,5	D46037R2505
38	-	2x5	4x9	2x7	0,5	D46038R2505
41	-	2x6	4x9	2x8	0,6	D46041R2505
43	-	2x6	4x10	2x8	0,6	D46043R2505
45	-	2x6	4x10	2x9	0,7	D46045R2505
33	1x5	1x4	5x7	2x7	0,4	D47033R2505
35	1x6	1x5	5x8	2x7	0,4	D47035R2505
37	1x6	1x5	5x9	2x7	0,4	D47037R2505
38	1x6	1x5	5x9	2x7	0,4	D47038R2505
41	1x6	1x5	5x9	2x8	0,6	D47041R2505
43	1x6	1x5	5x10	2x8	0,6	D47043R2505
45	1x6	1x5	5x10	2x9	0,7	D47045R2505
35	-	3x5	6x7	3x7	0,4	D49035R2505
37	1x5	3x5	6x7	3x7	0,5	D49037R2505
38	1x5	3x5	6x8	3x7	0,6	D49038R2505
41	1x5	3x5	6x8	3x7	0,6	D49041R2505
43	1x5	3x5	6x9	3x8	0,7	D49043R2505
45	1x5	3x5	6x10	3x8	0,7	D49045R2505
48	1x5	3x5	6x10	3x9	0,8	D49048R2505
51	1x6	3x5	6x10	3x9	0,8	D49051R2505



## Tiges :

Shank rod, Hex 25- R28

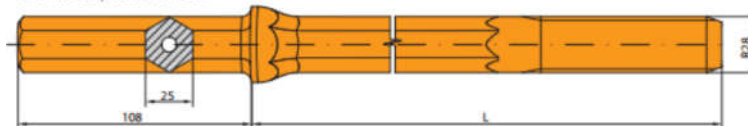

Hex (mm)	Filetage	Longueur (mm)	Poids (kg)	Référence
25	R28	610	2,8	25318061
25	R28	760	3,4	25318076
25	R28	1000	4,3	25318100
25	R28	1220	5,2	25318122
25	R28	1600	6,6	25318160
25	R28	1830	7,5	25318183
25	R28	2435	9,9	25318243
25	R28	3050	12,3	25318305
25	R28	3660	15,0	25318366

R28

Drifter rod, R28 - Hex 28 - R28

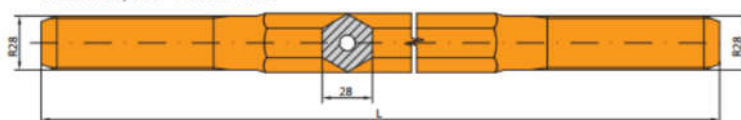

Hex (mm)	Filetage	Longueur (mm)	Poids (kg)	Référence
28	R28/R28	1220	6,0	28698122
28	R28/R28	1525	7,5	28698152
28	R28/R28	1830	8,8	28698183
28	R28/R28	2435	11,7	28698243
28	R28/R28	3050	14,6	28698305
28	R28/R28	3660	17,6	28698366
28	R28/R28	4305	20,7	28698430

Drifter rod, R32 - Hex 28 - R28

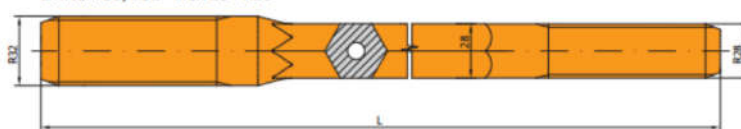

Hex (mm)	Filetage	Longueur (mm)	Poids (kg)	Référence
28	R32/R28	1220	6,3	28691122
28	R32/R28	1525	7,8	28691152
28	R32/R28	1830	9,3	28691183
28	R32/R28	2435	12,4	28691243
28	R32/R28	3050	15,5	28691305
28	R32/R28	3660	18,6	28691366
28	R32/R28	4305	21,8	28691430

## Tiges :

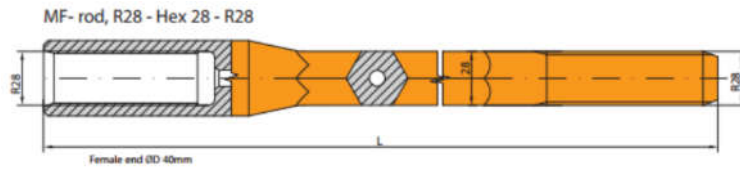

Hex (mm)	Filetage	Longueur (mm)	Poids (kg)	Référence
28	R28/R28	1220	6,6	26818122
28	R28/R28	1525	8,1	26818152
28	R28/R28	1830	9,6	26818183
28	R28/R28	2435	12,7	26818243
28	R28/R28	3050	15,7	26818305
28	R28/R28	3660	18,8	26818366
28	R28/R28	4305	22,1	26818430

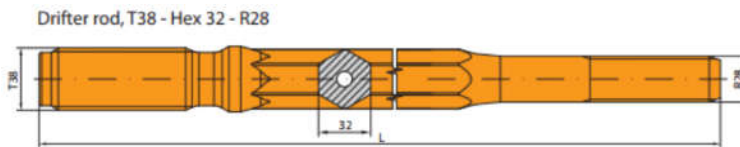

Hex (mm)	Filetage	Longueur (mm)	Poids (kg)	Référence
32	T38/R28	1830	11,3	21872183
32	T38/R28	2435	15,1	21872243
32	T38/R28	3050	19,1	21872305
32	T38/R28	3660	22,9	21872366
32	T38/R28	4305	27,1	21872430



## Manchons :

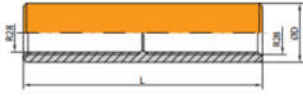

D (mm)	Filetage	L (mm)	Poids (kg)	Référence
39	R28/R28	140	0,8	3981800

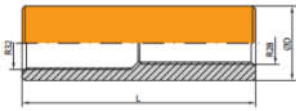

D (mm)	Filetage	L (mm)	Poids (kg)	Référence
44	R32/R28	150	1,2	3981400

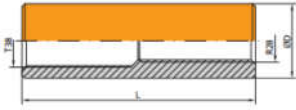

D (mm)	Filetage	L (mm)	Poids (kg)	Référence
55	T38/R28	165	2,3	3927800

R28

## Taillants :



D46



D47

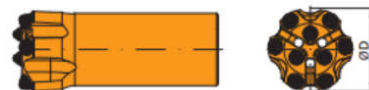

D49

Diamètre (mm)	Trous de soufflage (mm)		Boutons (mm)		Poids (kg)	Référence
	Latéral (q x d)	Face (q x d)	Latéral (q x d)	Face (q x d)		
37	-	2x5	4x8	2x7	0,5	D46037R2805
38	-	2x5	4x9	2x7	0,5	D46038R2805
41	-	2x6	4x9	2x8	0,6	D46041R2805
43	-	2x6	4x10	2x8	0,6	D46043R2805
45	-	2x6	4x10	2x9	0,7	D46045R2805
37	1x6	1x5	5x9	2x7	0,5	D47037R2805
38	1x6	1x5	5x9	2x7	0,5	D47038R2805
41	1x6	1x5	5x9	2x8	0,6	D47041R2805
43	1x6	1x5	5x10	2x8	0,7	D47043R2805
45	1x6	1x5	5x10	2x9	0,7	D47045R2805
37	1x5	3x5	6x7	3x7	0,5	D49037R2805
38	1x5	3x5	6x8	3x7	0,6	D49038R2805
41	1x5	3x5	6x8	3x7	0,6	D49041R2805
43	1x5	3x5	6x9	3x8	0,7	D49043R2805
45	1x5	3x5	6x10	3x8	0,7	D49045R2805
48	1x5	3x5	6x10	3x9	0,7	D49048R2805
51	1x6	3x5	6x10	3x9	0,8	D49051R2805



## Tiges :

Shank rod, Hex 25 - R32

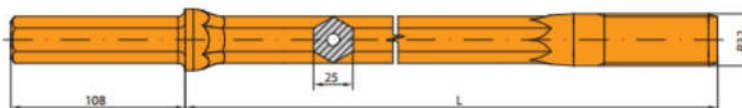

Hex (mm)	Filetage	Longueur (mm)	Poids (kg)	Référence
25	R32	610	3,0	25314061
25	R32	760	3,5	25314076
25	R32	1000	4,5	25314100
25	R32	1220	5,3	25314122
25	R32	1600	6,8	25314160
25	R32	1830	7,7	25314183
25	R32	2435	10,0	25314243
25	R32	3050	12,4	25314305
25	R32	3660	15,1	25314366

Drifter rod, R32 - Hex 32 - R32

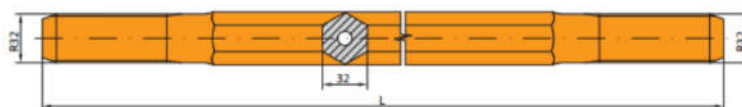

Hex (mm)	Filetage	Longueur (mm)	Poids (kg)	Référence
32	R32/R32	915	5,6	21414091
32	R32/R32	1000	6,2	21414100
32	R32/R32	1220	7,6	21414122
32	R32/R32	1525	9,5	21414152
32	R32/R32	1830	11,5	21414183
32	R32/R32	2435	15,3	21414243
32	R32/R32	3050	19,3	21414305
32	R32/R32	3660	23,2	21414366
32	R32/R32	4305	27,3	21414430
32	R32/R32	4915	31,2	21414491
32	R32/R32	5490	34,8	21414549

Drifter rod, R38 - Hex 32 - R32

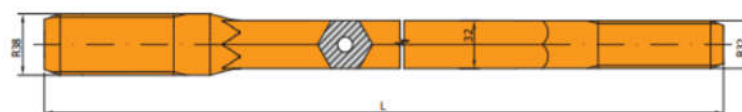

Hex (mm)	Filetage	Longueur (mm)	Poids (kg)	Référence
32	R38/R32	915	5,8	21412091
32	R38/R32	1000	6,4	21412100
32	R38/R32	1220	7,8	21412122
32	R38/R32	1525	9,7	21412152
32	R38/R32	1830	11,7	21412183
32	R38/R32	2435	15,5	21412243
32	R38/R32	3050	19,5	21412305
32	R38/R32	3660	23,4	21412366
32	R38/R32	4305	27,5	21412430
32	R38/R32	4915	31,4	21412491
32	R38/R32	5490	35,0	21412549

R32



## Tiges :

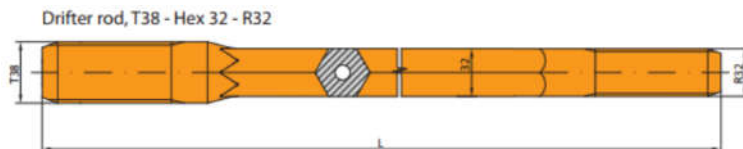

Hex (mm)	Filetage	Longueur (mm)	Poids (kg)	Référence
32	T38/R32	915	5,8	21472091
32	T38/R32	1000	6,4	21472100
32	T38/R32	1220	7,8	21472122
32	T38/R32	1525	9,7	21472152
32	T38/R32	1830	11,7	21472183
32	T38/R32	2435	15,5	21472243
32	T38/R32	3050	19,5	21472305
32	T38/R32	3660	23,4	21472366
32	T38/R32	4305	27,5	21472430
32	T38/R32	4915	31,4	21472491
32	T38/R32	5490	35,0	21472549

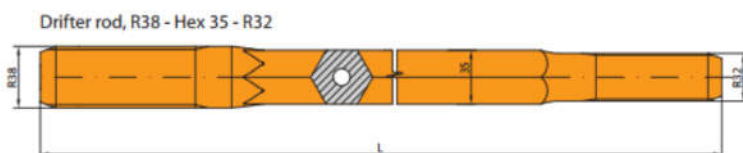

Hex (mm)	Filetage	Longueur (mm)	Poids (kg)	Référence
35	R38/R32	915	6,6	19412091
35	R38/R32	1000	7,3	19412100
35	R38/R32	1220	8,8	19412122
35	R38/R32	1525	11,1	19412152
35	R38/R32	1830	13,3	19412183
35	R38/R32	2435	17,6	19412243
35	R38/R32	3050	22,1	19412305
35	R38/R32	3660	26,5	19412366
35	R38/R32	4305	31,2	19412430
35	R38/R32	4915	35,6	19412491
35	R38/R32	5490	39,8	19412549

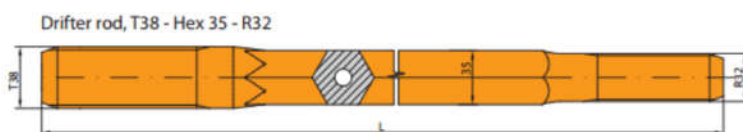

Hex (mm)	Filetage	Longueur (mm)	Poids (kg)	Référence
35	T38/R32	915	7,2	19472091
35	T38/R32	1000	7,9	19472100
35	T38/R32	1220	9,6	19472122
35	T38/R32	1525	12,0	19472152
35	T38/R32	1830	14,4	19472183
35	T38/R32	2435	19,2	19472243
35	T38/R32	3050	24,0	19472305
35	T38/R32	3660	28,3	19472366
35	T38/R32	4305	33,3	19472430
35	T38/R32	4915	38,1	19472491
35	T38/R32	5490	33,3	19472549



## Tiges :

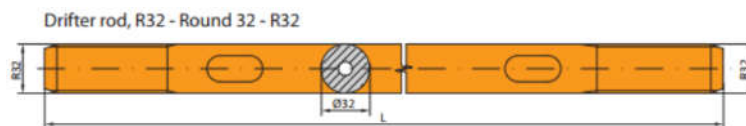

Diam. (mm)	Filetage	Longueur (mm)	Poids (kg)	Référence
32	R32/R32	915	5,2	22414091
32	R32/R32	1000	5,7	22414100
32	R32/R32	1220	6,7	22414122
32	R32/R32	1525	9,0	22414152
32	R32/R32	1830	10,1	22414183
32	R32/R32	2435	13,5	22414243
32	R32/R32	3050	16,9	22414305
32	R32/R32	3660	20,3	22414366
32	R32/R32	4305	28,5	22414430
32	R32/R32	4915	33,0	22414491
32	R32/R32	5490	36,8	22414549

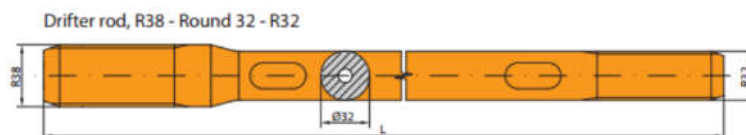

Diam. (mm)	Filetage	Longueur (mm)	Poids (kg)	Référence
32	R38/R32	915	5,3	22412091
32	R38/R32	1000	5,8	22412100
32	R38/R32	1220	7,1	22412122
32	R38/R32	1525	8,9	22412152
32	R38/R32	1830	10,6	22412183
32	R38/R32	2435	14,2	22412243
32	R38/R32	3050	17,8	22412305
32	R38/R32	3660	21,4	22412366
32	R38/R32	4305	25,2	22412430
32	R38/R32	4915	28,8	22412491
32	R38/R32	5490	32,1	22412549

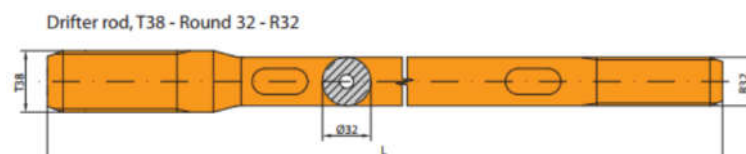

Diam. (mm)	Filetage	Longueur (mm)	Poids (kg)	Référence
32	T38/R32	915	5,3	22472091
32	T38/R32	1000	5,8	22472100
32	T38/R32	1220	7,1	22472122
32	T38/R32	1525	8,9	22472152
32	T38/R32	1830	10,6	22472183
32	T38/R32	2435	14,2	22472243
32	T38/R32	3050	17,8	22472305
32	T38/R32	3660	21,4	22472366
32	T38/R32	4305	25,2	22472430
32	T38/R32	4915	28,8	22472491
32	T38/R32	5490	32,1	22472549

R32

## Tiges :

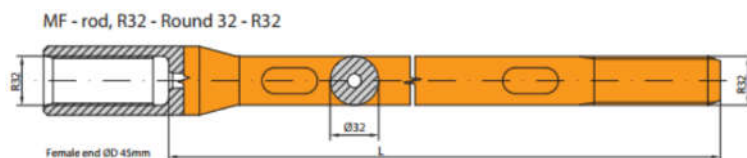

Diam. (mm)	Filetage	Longueur (mm)	Poids (kg)	Référence
32	R32/R32	915	5,4	26111091
32	R32/R32	1000	5,9	26111100
32	R32/R32	1220	7,2	26111122
32	R32/R32	1525	9,0	26111152
32	R32/R32	1830	10,6	26111183
32	R32/R32	2435	14,4	26111243
32	R32/R32	3050	17,6	26111305
32	R32/R32	3660	20,8	26111366
32	R32/R32	4305	24,8	26111430
32	R32/R32	4915	28,8	26111491
32	R32/R32	5490	32,1	26111549

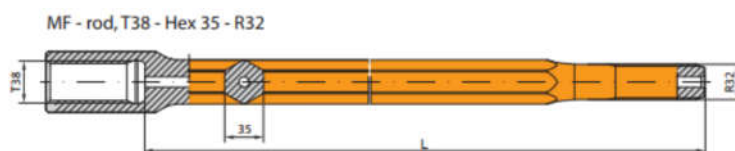

Hex (mm)	Filetage	Longueur (mm)	Poids (kg)	Référence
35	T38/R32	915	7,4	26979091
35	T38/R32	1000	8,1	26979100
35	T38/R32	1220	9,8	26979122
35	T38/R32	1525	12,2	26979152
35	T38/R32	1830	14,7	26979183
35	T38/R32	2435	19,4	26979243
35	T38/R32	3050	24,3	26979305
35	T38/R32	3660	29,1	26979366
35	T38/R32	4305	34,2	26979430
35	T38/R32	4915	39,0	26979491



## Manchons :

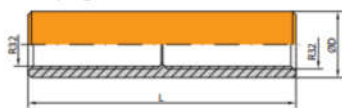

D (mm)	Filetage	L (mm)	Poids (kg)	Référence
45	R32/R32	150	0,9	3941400

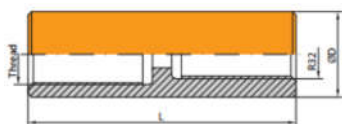

D (mm)	Filetage	L (mm)	Poids (kg)	Référence
55	R38/R32	175	2,3	3941201
55	T38/R32	185	2,4	3947201
64	T45/R32	185	3,3	3937401

R32

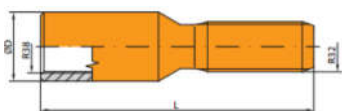

D (mm)	Filetage	L (mm)	Poids (kg)	Référence
55	R38/R32	210	0,9	3941206

## Taillants :

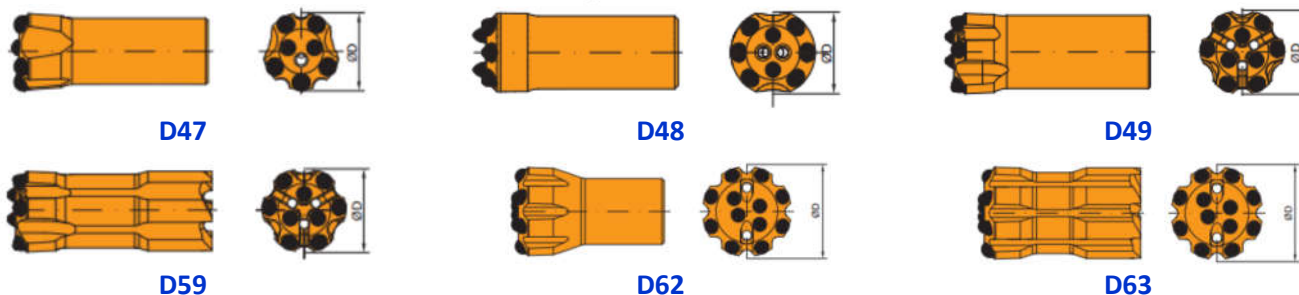

Diamètre (mm)	Trous de soufflage (mm)		Boutons (mm)		Poids (kg)	Référence
	Latéral (q x d)	Face (q x d)	Latéral (q x d)	Face (q x d)		
43	2x6	1x5	5x10	2x8	0,7	D47043R3205
45	2x6	1x5	5x10	2x9	0,7	D47045R3205
48	2x6	1x6	5x11	2x9	0,8	D47048R3205
51	2x6	1x6	5x12	2x10	1,0	D47051R3205
43	1x6	2x6	6x9	2x9	0,6	D48043R3205
45	1x6	2x6	6x10	2x9	0,7	D48045R3205
48	1x6	2x6	6x10	2x9	0,8	D48048R3205
51	1x6	2x7	6x11	2x9	1,1	D48051R3205
54	1x6	2x7	6x11	2x9	1,2	D48054R3205
43	1x5	3x5	6x9	3x8	0,6	D49043R3205
45	1x5	3x5	6x10	3x8	0,7	D49045R3205
48	1x5	3x5	6x10	3x9	0,8	D49048R3205
51	1x6	3x6	6x10	3x9	0,9	D49051R3205
54	1x6	3x6	6x11	3x9	1,1	D49054R3205
57	1x6	3x6	6x11	3x10	1,1	D49057R3205
61	1x6	3x6	6x12	3x10	1,2	D49061R3205
64	1x6	3x6	6x12	3x11	1,4	D49064R3205
51	1x6	3x6	6x10	3x9	1,3	D59051R3205
54	1x6	3x6	6x11	3x9	1,5	D59054R3205
57	1x6	3x6	6x11	3x10	1,7	D59057R3205
61	1x6	3x6	6x12	3x10	2,1	D59061R3205
64	1x6	3x6	6x12	3x11	2,3	D59064R3205
64	-	2x8	8x11	4x10	1,7	D62064R3215
70	-	2x8	8x12	4x11	1,8	D62070R3215
76	-	2x8	8x13	4x12	2,7	D62076R3215
89	-	2x8	8x14	5x13	3,8	D62089R3215
102	-	2x9	8x15	6x14	4,7	D62089R3215
64	-	2x8	8x11	4x10	2,3	D63064R3215
70	-	2x8	8x12	4x11	2,9	D63070R3215
76	-	2x8	8x13	4x12	2,7	D63076R3215
89	-	2x8	8x14	5x13	3,8	D63089R3215
102	-	2x9	8x15	6x14	4,7	D63089R3215



## Tiges :

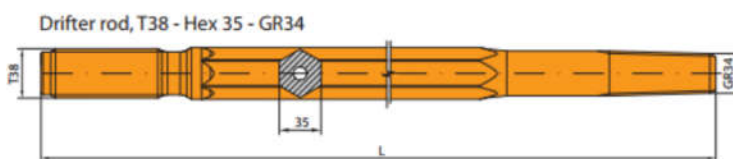

Hex (mm)	Filetage	Longueur (mm)	Poids (kg)	Référence
35	T38/GR34	915	7,2	10H35T38GR34091
35	T38/GR34	1000	7,9	10H35T38GR34100
35	T38/GR34	1220	9,6	10H35T38GR34122
35	T38/GR34	1525	12,0	10H35T38GR34152
35	T38/GR34	1830	14,4	10H35T38GR34183
35	T38/GR34	2435	19,2	10H35T38GR34243
35	T38/GR34	3050	23,5	10H35T38GR34305
35	T38/GR34	3660	28,3	10H35T38GR34366
35	T38/GR34	4305	33,9	10H35T38GR34430
35	T38/GR34	4915	38,7	10H35T38GR34491
35	T38/GR34	5490	43,3	10H35T38GR34549

GR34

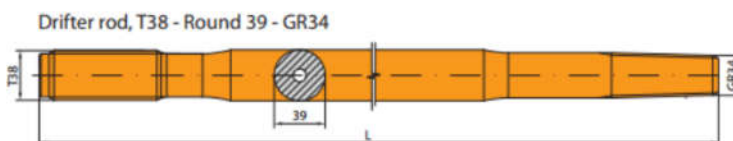

Diam. (mm)	Filetage	Longueur (mm)	Poids (kg)	Référence
39	T38/GR34	915	7,5	10R39T38GR34091
39	T38/GR34	1000	8,2	10R39T38GR34100
39	T38/GR34	1220	10,0	10R39T38GR34122
39	T38/GR34	1525	12,4	10R39T38GR34152
39	T38/GR34	1830	14,9	10R39T38GR34183
39	T38/GR34	2435	19,8	10R39T38GR34243
39	T38/GR34	3050	24,7	10R39T38GR34305
39	T38/GR34	3660	29,7	10R39T38GR34366
39	T38/GR34	4305	34,9	10R39T38GR34430
39	T38/GR34	4915	39,9	10R39T38GR34491
39	T38/GR34	5490	44,5	10R39T38GR34549

## Taillants :

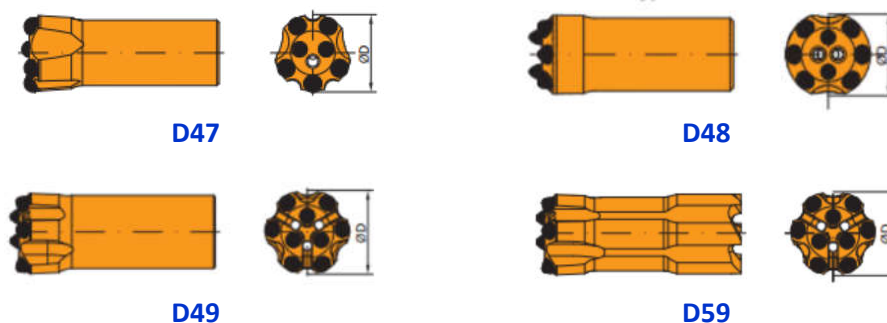

Diamètre (mm)	Trous de soufflage (mm)		Boutons (mm)		Poids (kg)	Référence
	Latéral (q x d)	Face (q x d)	Latéral (q x d)	Face (q x d)		
43	2x6	1x5	5x10	2x8	0,7	D47043GR3405
45	2x6	1x5	5x10	2x9	0,7	D47045GR3405
48	2x6	1x6	5x11	2x9	0,9	D47048GR3405
51	2x6	1x6	5x12	2x10	1,0	D47051GR3405
54	2x6	1x6	5x12	2x10	1,1	D47054GR3405
57	2x6	1x6	5x13	2x11	1,2	D47057GR3405
43	1x6	2x6	6x9	2x9	0,6	D48043GR3405
45	1x6	2x6	6x10	2x9	0,7	D48045GR3405
48	1x6	2x6	6x10	2x9	0,8	D48048GR3405
51	1x6	2x7	6x11	2x9	1,1	D48051GR3405
54	1x6	2x7	6x11	2x9	1,2	D48054GR3405
57	1x6	2x7	6x12	2x10	1,3	D48057GR3405
43	1x5	3x5	6x9	3x8	0,6	D49043GR3405
45	1x5	3x5	6x10	3x8	0,7	D49045GR3405
48	1x5	3x5	6x10	3x9	0,8	D49048GR3405
51	1x6	3x6	6x10	3x9	0,9	D49051GR3405
54	1x6	3x6	6x11	3x9	1,1	D49054GR3405
57	1x6	3x6	6x11	3x10	1,1	D49057GR3405
51	1x6	3x6	6x10	3x9	1,3	D59051GR3405
54	1x6	3x6	6x11	3x9	1,5	D59054GR3405
57	1x6	3x6	6x11	3x10	1,7	D59057GR3405
61	1x6	3x6	6x12	3x10	2,1	D59061GR3405
64	1x6	3x6	6x12	3x11	2,3	D59064GR3405



## Tiges :

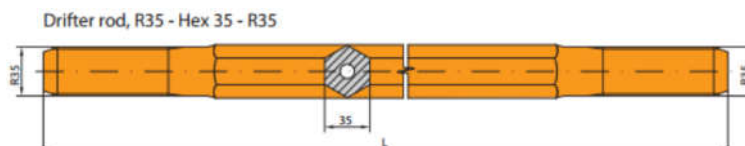

Hex (mm)	Filetage	Longueur (mm)	Poids (kg)	Référence
35	R35/R35	915	7,0	19515091
35	R35/R35	1000	7,7	19515100
35	R35/R35	1220	9,4	19515122
35	R35/R35	1525	11,8	19515152
35	R35/R35	1830	14,2	19515183
35	R35/R35	2435	18,8	19515243
35	R35/R35	3050	23,6	19515305
35	R35/R35	3660	28,3	19515366
35	R35/R35	4305	33,7	19515430
35	R35/R35	4915	38,5	19515491
35	R35/R35	5490	43,1	19515549

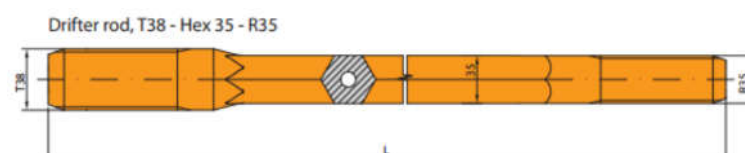

Hex (mm)	Filetage	Longueur (mm)	Poids (kg)	Référence
35	T38/R35	915	7,1	19275091
35	T38/R35	1000	7,8	19275100
35	T38/R35	1220	9,5	19275122
35	T38/R35	1525	11,9	19275152
35	T38/R35	1830	14,3	19275183
35	T38/R35	2435	19,1	19275243
35	T38/R35	3050	23,9	19275305
35	T38/R35	3660	28,7	19275366
35	T38/R35	4305	33,8	19275430
35	T38/R35	4915	38,6	19275491
35	T38/R35	5490	43,2	19275549

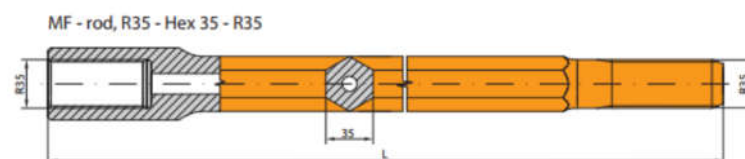

Hex (mm)	Filetage	Longueur (mm)	Poids (kg)	Référence
35	R35/R35	915	7,6	26414091
35	R35/R35	1000	8,3	26414100
35	R35/R35	1220	10,0	26414122
35	R35/R35	1525	12,4	26414152
35	R35/R35	1830	14,8	26414183
35	R35/R35	2435	19,6	26414243
35	R35/R35	3050	24,4	26414305
35	R35/R35	3660	29,2	26414366
35	R35/R35	4305	34,3	26414430
35	R35/R35	4915	39,1	26414491
35	R35/R35	5490	43,7	26414549

R35



## Tiges :

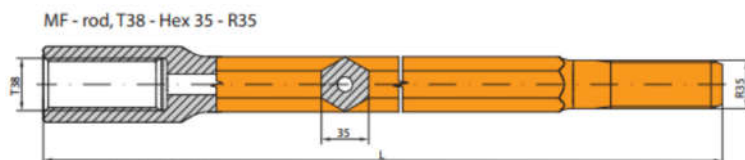

Hex (mm)	Filetage	Longueur (mm)	Poids (kg)	Référence
35	T38/R35	915	7,7	26975091
35	T38/R35	1000	8,4	26975100
35	T38/R35	1220	10,2	26975122
35	T38/R35	1525	12,6	26975152
35	T38/R35	1830	15,0	26975183
35	T38/R35	2435	19,8	26975243
35	T38/R35	3050	24,6	26975305
35	T38/R35	3660	29,4	26975366
35	T38/R35	4305	34,5	26975430
35	T38/R35	4915	39,3	26975491
35	T38/R35	5490	43,9	26975549

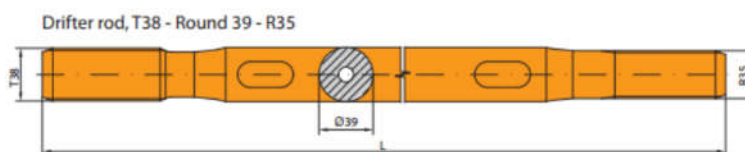

Diam. (mm)	Filetage	Longueur (mm)	Poids (kg)	Référence
39	T38/R35	915	7,2	23275091
39	T38/R35	1000	7,9	23275100
39	T38/R35	1220	9,7	23275122
39	T38/R35	1525	12,1	23275152
39	T38/R35	1830	14,6	23275183
39	T38/R35	2435	19,5	23275243
39	T38/R35	3050	23,8	23275305
39	T38/R35	3660	28,8	23275366
39	T38/R35	4305	33,9	23275430
39	T38/R35	4915	39,5	23275491
39	T38/R35	5490	44,2	23275549



## Manchons :

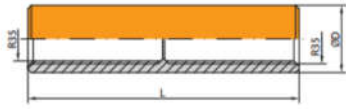

D (mm)	Filetage	L (mm)	Poids (kg)	Référence
51	R35/R35	150	1,3	3953500

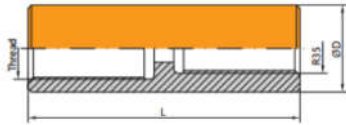

D (mm)	Filetage	L (mm)	Poids (kg)	Référence
55	T38/R35	185	2,2	3953201
64	T45/R35	185	3,1	3953301

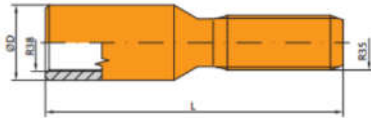

D (mm)	Filetage	L (mm)	Poids (kg)	Référence
55	R38/R35	210	1,9	3953206

R35

## Taillants :

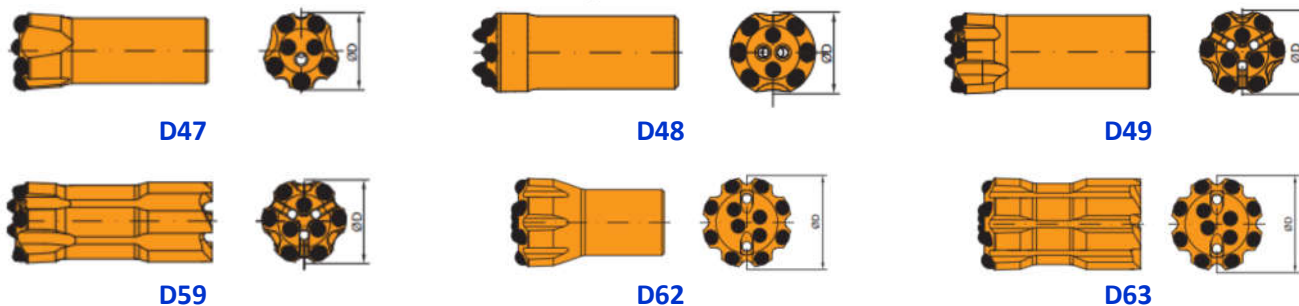

Diamètre (mm)	Trous de soufflage (mm)		Boutons (mm)		Poids (kg)	Référence
	Latéral (q x d)	Face (q x d)	Latéral (q x d)	Face (q x d)		
45	2x6	1x5	5x10	2x9	0,7	D47045R3505
48	2x6	1x6	5x11	2x9	0,8	D47048R3505
51	2x6	1x6	5x12	2x10	1,0	D47051R3505
54	2x6	1x6	5x12	2x10	1,1	D47054R3505
45	1x6	2x6	6x10	2x9	0,7	D48045R3505
48	1x6	2x6	6x10	2x9	0,8	D48048R3505
51	1x6	2x7	6x11	2x9	1,1	D48051R3505
54	1x6	2x7	6x11	2x9	1,2	D48054R3505
45	1x5	3x5	6x10	3x8	0,7	D49045R3505
48	1x5	3x5	6x10	3x9	0,8	D49048R3505
51	1x6	3x6	6x10	3x9	0,9	D49051R3505
54	1x6	3x6	6x11	3x9	1,1	D49054R3505
57	1x6	3x6	6x11	3x10	1,1	D49057R3505
61	1x6	3x6	6x12	3x10	1,2	D49061R3505
64	1x6	3x6	6x12	3x11	1,4	D49064R3505
51	1x6	3x6	6x10	3x9	1,2	D59051R3505
54	1x6	3x6	6x11	3x9	1,4	D59054R3505
57	1x6	3x6	6x11	3x10	1,6	D59057R3505
61	1x6	3x6	6x12	3x10	2,0	D59061R3505
64	1x6	3x6	6x12	3x11	2,2	D59064R3505
64	-	2x8	8x11	4x10	1,7	D62064R3515
70	-	2x8	8x12	4x11	1,8	D62070R3515
76	-	2x8	8x13	4x12	2,7	D62076R3515
89	-	2x8	8x14	5x13	3,8	D62089R3515
102	-	2x9	8x15	6x14	4,7	D62089R3515
64	-	2x8	8x11	4x10	2,3	D63064R3215
70	-	2x8	8x12	4x11	2,9	D63070R3215
76	-	2x8	8x13	4x12	2,7	D63076R3215
89	-	2x8	8x14	5x13	3,8	D63089R3215
102	-	2x9	8x15	6x14	4,7	D63089R3215



## Tiges :

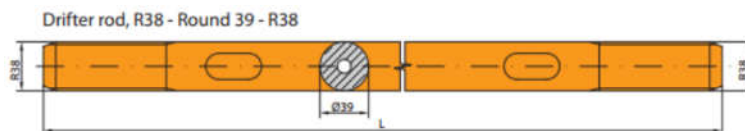

Diam. (mm)	Filetage	Longueur (mm)	Poids (kg)	Référence
39	R38/R38	915	7,2	23212091
39	R38/R38	1000	7,9	23212100
39	R38/R38	1220	9,8	23212122
39	R38/R38	1525	12,2	23212152
39	R38/R38	1830	14,7	23212183
39	R38/R38	2435	19,6	23212243
39	R38/R38	3050	24,5	23212305
39	R38/R38	3660	29,5	23212366
39	R38/R38	4305	34,7	23212430
39	R38/R38	4915	39,6	23212491
39	R38/R38	5490	44,4	23212549

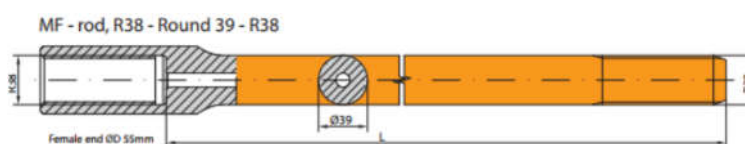

Diam. (mm)	Filetage	Longueur (mm)	Poids (kg)	Référence
39	R38/R38	915	7,9	26213091
39	R38/R38	1000	8,6	26213100
39	R38/R38	1220	10,4	26213122
39	R38/R38	1525	12,8	26213152
39	R38/R38	1830	15,3	26213183
39	R38/R38	2435	20,2	26213243
39	R38/R38	3050	25,1	26213305
39	R38/R38	3660	30,1	26213366
39	R38/R38	4305	35,3	26213430
39	R38/R38	4915	40,2	26213491
39	R38/R38	5490	44,9	26213549

R38

## Manchons :

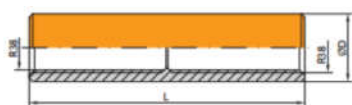

D (mm)	Filetage	L (mm)	Poids (kg)	Référence
55	R38/R38	160	1,6	3921200



D (mm)	Filetage	L (mm)	Poids (kg)	Référence
55	T38/R38	190	2,1	3927101
64	T45/R38	190	3,2	3937201

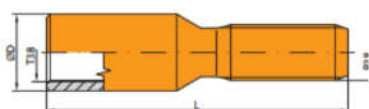

D (mm)	Filetage	L (mm)	Poids (kg)	Référence
55	T38/R38	240	2,5	3927206

## Taillants :



Drop Center D60

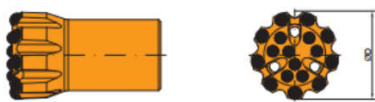

Face Plate D62

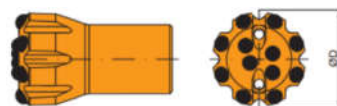

Heavy Duty D62



Drop Center D61

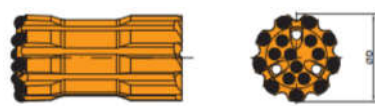

Face Plate D63



Heavy Duty D63

Diamètre (mm)	Trous de soufflage (mm)		Boutons (mm)		Poids (kg)	Référence
	Latéral (q x d)	Face (q x d)	Latéral (q x d)	Face (q x d)		
64	-	4x8	8x10	5x9	1,7	D60064R3805
70	-	4x8	8x11	5x10	1,8	D60070R3805
76	-	4x8	8x12	5x11	2,4	D60076R3805
89	-	4x9	8x13	5x12	3,5	D60089R3805
102	-	4x9	8x14	6x13	4,2	D60102R3805
64	-	3x8	9x10	8x8	1,7	D62064R3805
76	-	3x9	9x12	8x10	2,4	D62076R3805
89	-	3x10	9x13	9x11	3,5	D62089R3805
102	-	3x10	9x14	9x12	4,2	D62102R3805
64	-	2x9	8x11	4x10	1,8	D62064R3815
70	-	2x9	8x12	4x11	2,0	D62070R3815
76	-	2x10	8x13	4x12	2,9	D62076R3815
89	-	2x11	8x14	5x13	3,4	D62089R3815
102	-	2x11	8x15	6x14	4,5	D62102R3815
64	-	4x8	8x10	5x9	2,0	D61064R3805
70	-	4x8	8x11	5x10	3,0	D61070R3805
76	-	4x8	8x12	5x11	3,6	D61076R3805
89	-	4x9	8x13	5x12	5,1	D61089R3805
102	-	4x9	8x14	6x13	7,2	D61102R3805
64	-	3x8	9x10	8x8	2,0	D63064R3805
76	-	3x9	9x12	8x10	3,6	D63076R3805
89	-	3x10	9x13	9x11	5,1	D63089R3805
102	-	3x10	9x14	9x12	7,2	D63102R3805
64	-	2x9	8x11	4x10	2,3	D63064R3815
70	-	2x9	8x12	4x11	2,8	D63070R3815
76	-	2x10	8x13	4x12	3,4	D63076R3815
89	-	2x11	8x14	5x13	4,9	D63089R3815
102	-	2x11	8x15	6x14	7,2	D63102R3815



## Tiges :

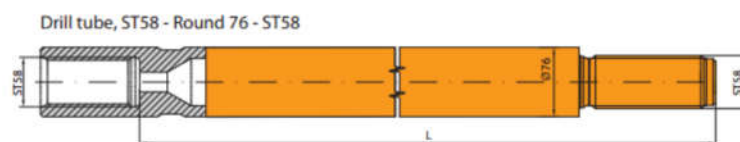

Diam. (mm)	Filetage	Longueur (mm)	Poids (kg)	Référence
76	ST58/ST58	1525	31,9	12R76ST58ST58152
76	ST58/ST58	1830	34,6	12R76ST58ST58183

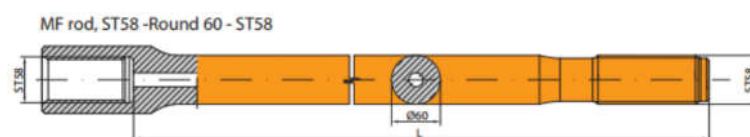

Diam. (mm)	Filetage	Longueur (mm)	Poids (kg)	Référence
60	ST58/ST58	3660	72,7	11R60ST58ST58366
60	ST58/ST58	4265	86,7	11R60ST58ST58426
60	ST58/ST58	5490	109,6	11R60ST58ST58549
60	ST58/ST58	6095	121,7	11R60ST58ST58609

## Manchons :

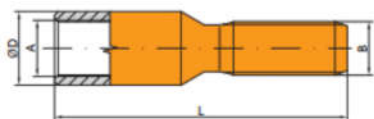

Filetage A/B	L A (mm)	L B (mm)	Poids (kg)	Référence
T51/ST58	76	285	5,7	3922506
ST58/T51	84	310	6,2	3952206
ST58/GT60	84	346	7,5	3952606

ST58

## Taillants :



Drop Center D60

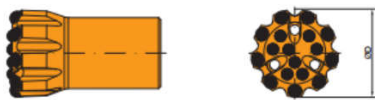

Face Plate D62

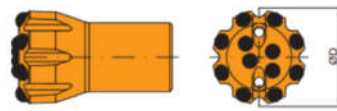

Heavy Duty D62

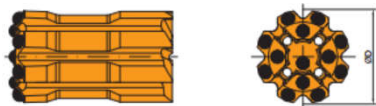

Drop Center D61

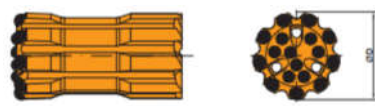

Face Plate D63

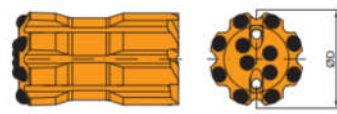

Heavy Duty D63

Diamètre (mm)	Trous de soufflage (mm)		Boutons (mm)		Poids (kg)	Référence
	Latéral (q x d)	Face (q x d)	Latéral (q x d)	Face (q x d)		
89	-	4x10	8x13	5x12	3,8	D60089ST5805
102	-	4x10	8x14	6x13	5,4	D60102ST5805
115	-	4x11	8x15	6x14	7,0	D60115ST5805
127	-	4x11	8x15	4x15,4x13	9,0	D60127ST5805
89	-	3x11	9x13	9x11	3,8	D62089ST5805
102	-	3x12	9x14	9x12	5,5	D62102ST5805
115	-	3x12	9x15	10x13	7,1	D62115ST5805
127	-	3x13	9x16	10x14	9,3	D62127ST5805
89	-	2x13	8x14	5x13	3,8	D62089ST5815
102	-	2x13	8x15	6x14	5,5	D62102ST5815
115	-	2x14	8x16	6x15	7,1	D62115ST5815
127	-	2x14	8x16	8x15	9,3	D62127ST5815
89	-	4x10	8x13	5x12	4,5	D61089ST5805
102	-	4x10	8x14	6x13	6,8	D61102ST5805
115	-	4x11	8x15	6x14	8,8	D61115ST5805
127	-	4x11	8x15	4x15,4x13	10,4	D61127ST5805
89	-	3x11	9x13	9x11	4,8	D63089ST5805
102	-	3x12	9x14	9x12	6,4	D63102ST5805
115	-	3x12	9x15	10x13	8,8	D63115ST5805
127	-	3x13	9x16	10x14	10,4	D63127ST5805
89	-	2x13	8x14	5x13	4,5	D63089ST5815
102	-	2x13	8x15	6x14	6,8	D63102ST5815
115	-	2x14	8x16	6x15	8,8	D63115ST5815
127	-	2x14	8x16	8x15	10,4	D63127ST5815



## Tiges :

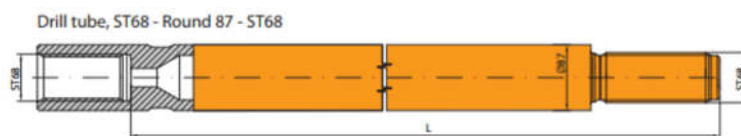

Diam. (mm)	Filetage	Longueur (mm)	Poids (kg)	Référence
87	ST68/ST68	1525	41,9	12R87ST68ST68152
87	ST68/ST68	1830	49,6	12R87ST68ST68183

ST68



## Taillants :



Drop Center D60



Face Plate D62

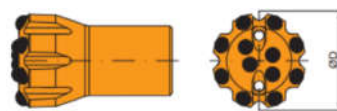

Heavy Duty D62



Drop Center D61

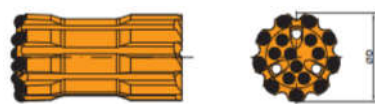

Face Plate D63



Heavy Duty D63

Diamètre (mm)	Trous de soufflage (mm)		Boutons (mm)		Poids (kg)	Référence
	Latéral (q x d)	Face (q x d)	Latéral (q x d)	Face (q x d)		
102	-	4x11	8x14	6x13	5,5	D60102ST6805
115	-	4x12	8x15	6x14	7,0	D60115ST6805
127	-	4x13	8x15	4x15,4x13	8,9	D60127ST6805
152	-	4x14	8x16	4x16,4x15	13,2	D60152ST6805
102	-	3x13	9x14	9x12	5,5	D62102ST6805
115	-	3x14	9x15	10x13	7,1	D62115ST6805
127	-	3x14	9x16	10x14	9,3	D62127ST6805
152	-	3x15	9x16	10x15	11,9	D62152ST6805
102	-	2x14	8x15	6x14	5,5	D62102ST6815
115	-	2x15	8x16	6x15	7,1	D62115ST6815
127	-	2x15	8x17	8x15	9,3	D62127ST6815
152	-	2x15	8x17	8x16	11,9	D62152ST6815
102	-	4x11	8x14	6x13	6,4	D61102ST6805
115	-	4x12	8x15	6x14	9,6	D61115ST6805
127	-	4x13	8x15	4x15,4x13	11,7	D61127ST6805
152	-	4x14	8x16	4x16,4x15	18,1	D61152ST6805
102	-	3x13	9x14	9x12	6,5	D63102ST6805
115	-	3x14	9x15	10x13	9,1	D63115ST6805
127	-	3x14	9x16	10x14	10,8	D63127ST6805
152	-	3x15	9x16	10x15	14,6	D63152ST6805
102	-	2x14	8x15	6x14	6,5	D63102ST6815
115	-	2x15	8x16	6x15	9,1	D63115ST6815
127	-	2x15	8x17	8x15	10,8	D63127ST6815
152	-	2x15	8x17	8x16	14,6	D63152ST6815



## Tiges :

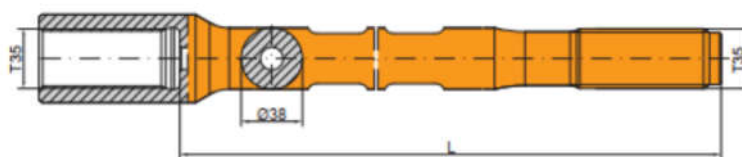

Hex (mm)	Filetage	Longueur (mm)	Poids (kg)	Référence
38	T35/T35	915	7,1	26323091
38	T35/T35	1220	9,5	26323122
38	T35/T35	1525	12,0	26323152
38	T35/T35	1830	14,5	26323183
38	T35/T35	2435	19,4	26323243
38	T35/T35	3050	24,3	26323305
38	T35/T35	3660	29,3	26323366
38	T35/T35	4265	34,1	26323427
38	T35/T35	4915	39,4	26323491
38	T35/T35	5490	44,0	26323549
38	T35/T35	6100	48,9	26323610

T35

## Taillants :

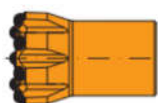

B50

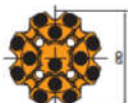

B51

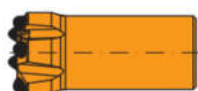
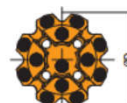

B58



B59



Diamètre (mm)	Trous de soufflage (mm)		Boutons (mm)		Poids (kg)	Référence
	Latéral (q x d)	Face (q x d)	Latéral (q x d)	Face (q x d)		
64	-	4x6	8x10	5x9	1,6	B50064T3505
70	-	4x6	8x11	5x10	1,9	B50070T3505
76	-	4x6	8x12	5x11	2,6	B50076T3505
64	-	4x6	8x10	5x9	2,1	B51064T3505
70	-	4x6	8x11	5x10	2,9	B51070T3505
76	-	4x6	8x12	5x11	3,7	B51076T3505
51	1x6	3x6	6x10	3x9	0,9	B58051T3505
54	1x6	3x6	6x11	3x9	1,1	B58054T3505
57	1x6	3x6	6x11	3x10	1,3	B58057T3505
51	1x6	3x6	6x10	3x9	1,2	B59051T3505
54	1x6	3x6	6x11	3x9	1,4	B59054T3505
57	1x6	3x6	6x11	3x10	1,6	B59057T3505



## Tiges :

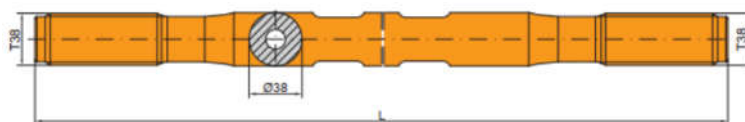

Diam. (mm)	Filetage	Longueur (mm)	Poids (kg)	Référence
38	T38/T38	915	7,0	23222091
38	T38/T38	1220	9,5	23222122
38	T38/T38	1525	11,9	23222152
38	T38/T38	1830	14,4	23222183
38	T38/T38	2435	19,3	23222243
38	T38/T38	3050	24,3	23222305
38	T38/T38	3660	29,2	23222366
38	T38/T38	4265	34,1	23222426
38	T38/T38	4915	39,3	23222491
38	T38/T38	5490	44,0	23222549
38	T38/T38	6100	48,9	23222610

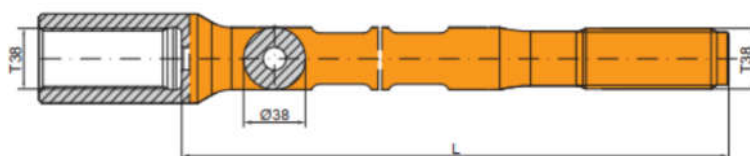

Diam. (mm)	Filetage	Longueur (mm)	Poids (kg)	Référence
38	T38/T38	915	7,1	26223091
38	T38/T38	1220	9,5	26223122
38	T38/T38	1525	12,0	26223152
38	T38/T38	1830	14,5	26223183
38	T38/T38	2435	19,4	26223243
38	T38/T38	3050	24,3	26223305
38	T38/T38	3660	29,3	26223366
38	T38/T38	4265	34,1	26223426
38	T38/T38	4915	39,4	26223491
38	T38/T38	5490	44,0	26223549
38	T38/T38	6100	48,9	26223610

T38

## Tiges :

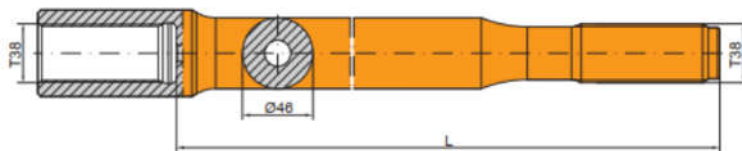

Diam. (mm)	Filetage	Longueur (mm)	Poids (kg)	Référence
46	T38/T38	915	9,5	266260913
46	T38/T38	1220	12,8	266261223
46	T38/T38	1525	16,2	266261523
46	T38/T38	1830	19,5	266261833
46	T38/T38	2435	26,2	266262433
46	T38/T38	3050	33,0	266263053
46	T38/T38	3660	39,7	266263663
46	T38/T38	4265	46,3	266264263
46	T38/T38	4915	53,5	266264913
46	T38/T38	5490	59,8	266265493
46	T38/T38	6100	66,5	266266103

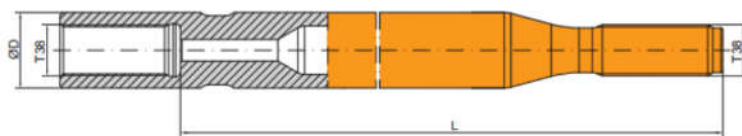

Diam. (mm)	Filetage	Longueur (mm)	Poids (kg)	Référence
56	T38/T38	1525	18,6	1256T38T38152
56	T38/T38	1830	22,1	1256T38T38183
56	T38/T38	3050	35,9	1256T38T38305
56	T38/T38	3660	42,8	1256T38T38366
63	T38/T38	3660	49,4	1263T38T38366

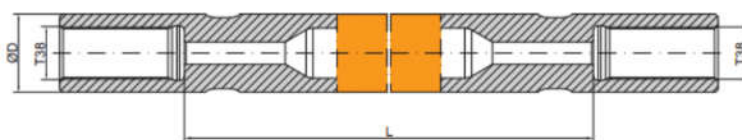

Diam. (mm)	Filetage	Longueur (mm)	Poids (kg)	Référence
56	T38/T38	1525	19,5	1356T38T38152
56	T38/T38	1830	23,0	1356T38T38183
56	T38/T38	3050	36,8	1356T38T38305
56	T38/T38	3660	43,7	1356T38T38366
63	T38/T38	3660	52,4	1363T38T38366



## Manchons :

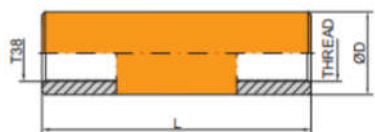

D (mm)	Filetage	L (mm)	Poids (kg)	Référence
56	T38/T38	180	2,0	3922200

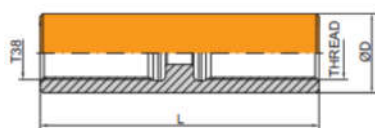

D (mm)	Filetage	L (mm)	Poids (kg)	Référence
56	T38/R32	185	2,4	3947201
56	T38/T38	200	2,5	3922201



Filetage	L (mm)	Poids (kg)	Référence
T38/R32	240	2,4	39472061
T38/T45	275	3,2	3922306



Filetage	L (mm)	Poids (kg)	Référence
T38/T38	265	1,9	3838T38T3800

T38

## Taillants :



Drop Center B50



Drop Center B60



Face Plate B52



Heavy Duty B52



Drop Center B51



Drop Center B61



Face Plate B53



Heavy Duty B53

Diamètre (mm)	Trous de soufflage (mm)		Boutons (mm)		Poids (kg)	Référence
	Latéral (q x d)	Face (q x d)	Latéral (q x d)	Face (q x d)		
64	-	4x8	8x10	5x9	1,7	B50064T3805
70	-	4x8	8x11	5x10	2,1	B50070T3805
76	-	4x8	8x12	5x11	2,7	B50076T3805
89	-	4x9	8x13	5x12	3,5	B50089T3805
102	-	4x9	8x14	6x13	4,8	B50102T3805
64	-	3x8	9x10	4x9	1,7	B60064T3805
70	-	3x8	9x11	4x10	2,1	B60070T3805
76	-	3x9	9x12	4x10	2,4	B60076T3805
89	-	3x10	9x12	7x11	3,9	B60089T3805
102	-	3x10	9x13	7x12	4,9	B60102T3805
64	-	3x8	9x10	8x8	1,7	B52064T3805
76	-	3x9	9x12	8x10	2,8	B52076T3805
89	-	3x10	9x13	9x11	3,5	B52089T3805
102	-	3x10	9x14	9x12	4,5	B52102T3805
64	-	2x9	8x11	4x10	1,8	B52064T3815
70	-	2x9	8x12	4x11	2,4	B52070T3815
76	-	2x10	8x13	4x12	2,8	B52076T3815
89	-	2x11	8x14	5x13	3,6	B52089T3815
102	-	2x11	8x15	6x14	5,0	B52102T3815
64	-	4x8	8x10	5x9	2,1	B51064T3805
70	-	4x8	8x11	5x10	2,9	B51070T3805
76	-	4x8	8x12	5x11	3,7	B51076T3805
89	-	4x9	8x13	5x12	5,2	B51089T3805
102	-	4x9	8x14	6x13	7,2	B51102T3805
64	-	3x8	9x10	4x9	1,9	B61064T3805
70	-	3x8	9x11	4x10	2,6	B61070T3805
76	-	3x9	9x12	4x10	3,3	B61076T3805
89	-	3x10	9x12	7x11	4,9	B61089T3805
102	-	3x10	9x13	7x12	6,7	B61102T3805
64	-	3x8	9x10	8x8	2,1	B53064T3805
76	-	3x9	9x12	8x10	3,6	B53076T3805
89	-	3x10	9x13	9x11	5,2	B53089T3805
102	-	3x10	9x14	9x12	6,4	B53102T3805
64	-	2x9	8x11	4x10	2,2	B53064T3815
70	-	2x9	8x12	4x11	3,1	B53070T3815
76	-	2x10	8x13	4x12	3,7	B53076T3815
89	-	2x11	8x14	5x13	5,2	B53089T3815
102	-	2x11	8x15	6x14	7,4	B53102T3815



## Tiges :

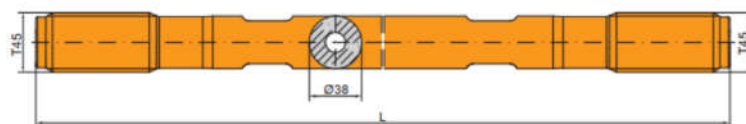

Diam. (mm)	Filetage	Longueur (mm)	Poids (kg)	Référence
38	T45/T45	915	8,1	23323091
38	T45/T45	1220	10,7	23323122
38	T45/T45	1525	13,4	23323152
38	T45/T45	1830	16,1	23323183
38	T45/T45	2435	21,3	23323243
38	T45/T45	3050	25,0	23323305
38	T45/T45	3660	30,0	23323366
38	T45/T45	4265	37,3	23323426
38	T45/T45	4915	43,0	23323491
38	T45/T45	5490	48,0	23323549
38	T45/T45	6100	53,3	23323610

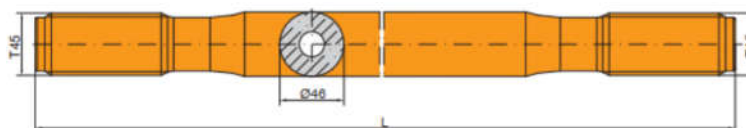

Diam. (mm)	Filetage	Longueur (mm)	Poids (kg)	Référence
46	T45/T45	915	8,7	18323091
46	T45/T45	1220	11,6	18323122
46	T45/T45	1525	14,5	18323152
46	T45/T45	1830	17,4	18323183
46	T45/T45	2435	23,1	18323243
46	T45/T45	3050	29,0	18323305
46	T45/T45	3660	34,8	18323366
46	T45/T45	4265	40,5	18323426
46	T45/T45	4915	46,7	18323491
46	T45/T45	6100	58,0	18323610

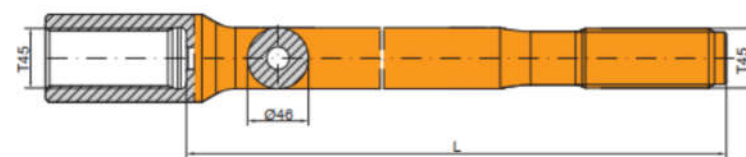

Diam. (mm)	Filetage	Longueur (mm)	Poids (kg)	Référence
46	T45/T45	1525	17,5	26626152
46	T45/T45	1830	20,0	26626183
46	T45/T45	2435	27,7	26626243
46	T45/T45	3050	34,6	26626305
46	T45/T45	3660	41,6	26626366
46	T45/T45	4265	47,0	26626426
46	T45/T45	4915	55,3	26626491
46	T45/T45	6100	68,6	26626610

T45



## Tiges :

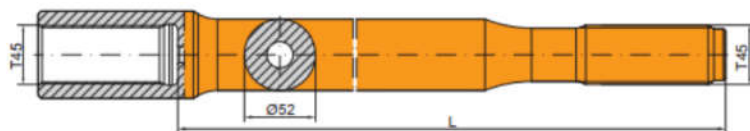

Diam. (mm)	Filetage	Longueur (mm)	Poids (kg)	Référence
52	T45/T45	1525	17,0	269291523
52	T45/T45	1830	21,3	269291833
52	T45/T45	2435	29,6	269292433
52	T45/T45	3050	38,2	269293053
52	T45/T45	3660	46,6	269293663
52	T45/T45	4265	54,7	269294263
52	T45/T45	4915	70,8	269294913
52	T45/T45	5490	72,7	269295493
52	T45/T45	6100	78,8	269296103

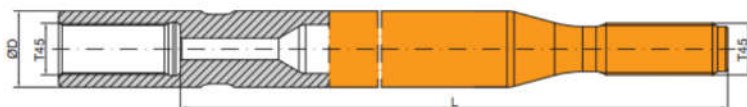

Diam. (mm)	Filetage	Longueur (mm)	Poids (kg)	Référence
63	T45/T45	1830	25,8	1263T45T45183
63	T45/T45	3660	49,6	1263T45T45366
63	T45/T45	4265	57,5	1263T45T45426
76	T45/T45	3660	72,7	1276T45T45366
76	T45/T45	4265	84,2	1276T45T45426

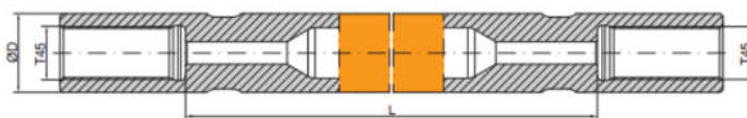

Diam. (mm)	Filetage	Longueur (mm)	Poids (kg)	Référence
63	T45/T45	1830	30,1	1363T45T45183
63	T45/T45	3660	54,1	1363T45T45366
63	T45/T45	4265	62,0	1363T45T45426
76	T45/T45	3660	79,5	1376T45T45366
76	T45/T45	4265	91,0	1376T45T45426



## Manchons :

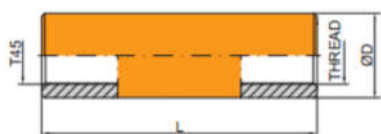

D (mm)	Filetage	L (mm)	Poids (kg)	Référence
64	T45/T38	180	2,9	3922300
64	T45/T45	180	2,5	3932300



D (mm)	Filetage	L (mm)	Poids (kg)	Référence
64	T45/T45	210	3,4	3932301

## Taillants :



Drop Center B50



Drop Center B60



Face Plate B52



Heavy Duty B52

Diamètre (mm)	Trous de soufflage (mm)		Boutons (mm)		Poids (kg)	Référence
	Latéral (q x d)	Face (q x d)	Latéral (q x d)	Face (q x d)		
70	-	4x8	8x11	5x10	2,3	B50070T4505
76	-	4x8	8x12	5x11	2,7	B50076T4505
89	-	4x9	8x13	5x12	3,8	B50089T4505
102	-	4x9	8x14	6x13	4,8	B50102T4505
115	-	4x9	8x15	6x14	6,0	B50115T4505
127	-	4x10	8x15	4x15, 4x13	8,8	B50127T4505
70	-	3x8	9x11	4x10	2,3	B60070T4505
76	-	3x9	9x12	4x10	2,7	B60076T4505
89	-	3x10	9x12	7x11	3,8	B60089T4505
102	-	3x10	9x13	7x12	4,8	B60102T4505
115	-	3x10	9x14	8x13	6,0	B60115T4505
127	-	3x10	9x16	8x15	7,1	B60127T4505
76	-	3x9	9x12	8x10	2,4	B52076T4505
89	-	3x10	9x13	9x11	3,9	B52089T4505
102	-	3x10	9x14	9x12	4,8	B52102T4505
115	-	3x10	9x15	10x13	6,5	B52115T4505
127	-	3x10	9x16	10x14	8,9	B52127T4505
70	-	2x9	8x12	4x11	2,3	B52070T4515
76	-	2x10	8x13	4x12	2,7	B52076T4515
89	-	2x11	8x14	5x13	3,5	B52089T4515
102	-	2x11	8x15	6x14	4,9	B52102T4515
115	-	2x12	8x16	6x15	6,5	B52115T4515
127	-	2x12	8x16	8x15	9,0	B52127T4515

T45

## Manchons :

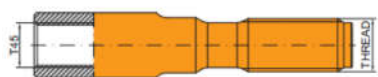

Filetage	L (mm)	Poids (kg)	Référence
T45/T38	240	3,2	3932206
T45/T51	275	3,8	39523065

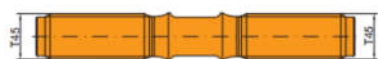

Filetage	L (mm)	Poids (kg)	Référence
T45/T45	265	2,4	3845T45T4500

## Taillants :

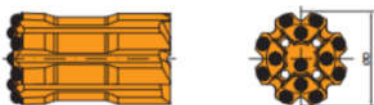

Drop Center B51



Drop Center B61



Face Plate B53

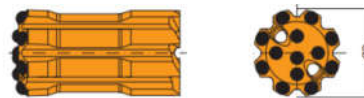

Heavy Duty B53

Diamètre (mm)	Trous de soufflage (mm)		Boutons (mm)		Poids (kg)	Référence
	Latéral (q x d)	Face (q x d)	Latéral (q x d)	Face (q x d)		
70	-	4x8	8x11	5x10	2,6	B51070T4505
76	-	4x8	8x12	5x11	3,3	B51076T4505
89	-	4x9	8x13	5x12	5,0	B51089T4505
102	-	4x9	8x14	6x13	6,9	B51102T4505
115	-	4x9	8x15	6x14	8,9	B51115T4505
127	-	4x10	8x15	4x15, 4x13	12,0	B51127T4505
70	-	3x8	9x11	4x10	2,8	B61070T4505
76	-	3x9	9x12	4x10	3,2	B61076T4505
89	-	3x10	9x12	7x11	5,3	B61089T4505
102	-	3x10	9x13	7x12	6,9	B61102T4505
115	-	3x10	9x14	8x13	8,8	B61115T4505
127	-	3x10	9x16	8x15	10,2	B61127T4505
76	-	3x9	9x12	8x10	3,2	B53076T4505
89	-	3x10	9x13	9x11	5,2	B53089T4505
102	-	3x10	9x14	9x12	6,6	B53102T4505
115	-	3x10	9x15	10x13	8,4	B53115T4505
127	-	3x10	9x16	10x14	11,8	B53127T4505
70	-	2x9	8x12	4x11	3,2	B53070T4515
76	-	2x10	8x13	4x12	3,5	B53076T4515
89	-	2x11	8x14	5x13	5,0	B53089T4515
102	-	2x11	8x15	6x14	6,6	B53102T4515
115	-	2x12	8x16	6x15	8,4	B53115T4515
127	-	2x12	8x16	8x15	11,7	B53127T4515



## Tiges :

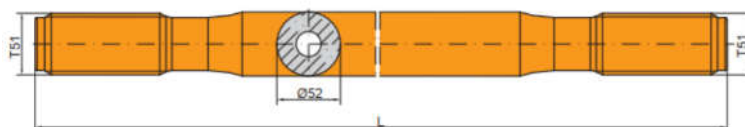

Diam. (mm)	Filetage	Longueur (mm)	Poids (kg)	Référence
52	T51/T51	915	11,3	28050091
52	T51/T51	1220	15,6	28050122
52	T51/T51	1525	19,8	28050152
52	T51/T51	1830	24,0	28050183
52	T51/T51	2435	32,8	28050243
52	T51/T51	3050	40,9	28050305
52	T51/T51	3660	49,3	28050366
52	T51/T51	4265	57,7	28050426
52	T51/T51	4915	66,7	28050491
52	T51/T51	6100	83,1	28050610

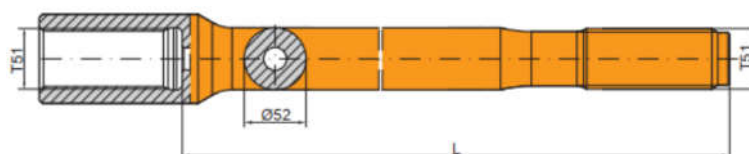

Diam. (mm)	Filetage	Longueur (mm)	Poids (kg)	Référence
52	T51/T51	1525	23,6	26929152
52	T51/T51	1830	27,9	26929183
52	T51/T51	2435	36,2	26929243
52	T51/T51	3050	44,8	26929305
52	T51/T51	3660	53,2	26929366
52	T51/T51	4265	61,6	26929426
52	T51/T51	4915	70,6	26929491
52	T51/T51	6100	87,5	26929610

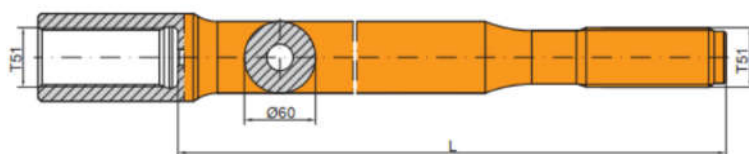

Diam. (mm)	Filetage	Longueur (mm)	Poids (kg)	Référence
60	T51/T51	1525	30,5	269691523
60	T51/T51	1830	36,6	269691833
60	T51/T51	2435	48,7	269692433
60	T51/T51	3050	59,5	269693053
60	T51/T51	3660	71,5	269693663
60	T51/T51	4265	83,0	269694263
60	T51/T51	4915	95,6	269694913
60	T51/T51	5490	106,7	269695493
60	T51/T51	6100	118,7	269696103

T51

## Tiges :

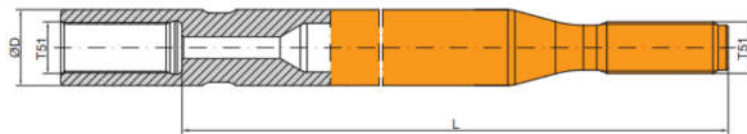

Diam. (mm)	Filetage	Longueur (mm)	Poids (kg)	Référence
76	T51/T51	1830	37,3	1276T51T51183
76	T51/T51	3660	72,0	1276T51T51366
76	T51/T51	4265	83,5	1276T51T51426
87	T51/T51	3660	95,8	1287T51T51366
87	T51/T51	4265	105,8	1287T51T51426

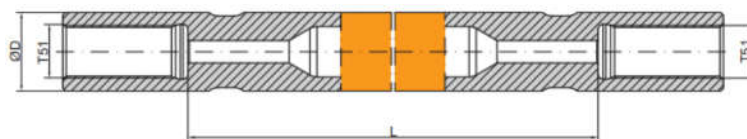

Diam. (mm)	Filetage	Longueur (mm)	Poids (kg)	Référence
76	T51/T51	1830	41,9	1376T51T51183
76	T51/T51	3660	76,5	1376T51T51366
76	T51/T51	4265	88,0	1376T51T51426
87	T51/T51	3660	105,5	1387T51T51366
87	T51/T51	4265	120,8	1387T51T51426

## Manchons :

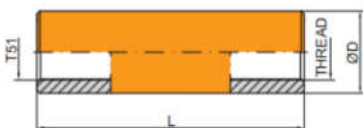

D (mm)	Filetage	L (mm)	Poids (kg)	Référence
72	T51/T51	210	4,8	3952532
74	T51/T45	195	3,9	3952300
74	T51/T51	210	4,7	3952500

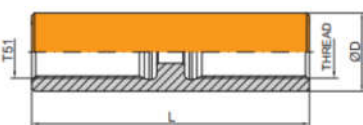

D (mm)	Filetage	L (mm)	Poids (kg)	Référence
76	T51/T45	215	5,3	3952301
76	T51/T51	230	5,3	3952501

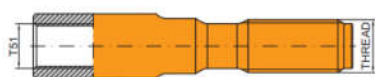

Filetage	L (mm)	Poids (kg)	Référence
T51/T45	270	4,6	3952306
T51/GT60	300	7,5	3954606



Filetage	L (mm)	Poids (kg)	Référence
T51/T51	310	3,8	3851T51T5100



## Taillants :

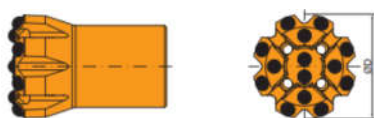

**Drop Center B50**

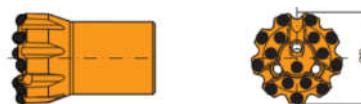

**Drop Center B60**



**Face Plate B52**



**Heavy Duty B52**

Diamètre (mm)	Trous de soufflage (mm)		Boutons (mm)		Poids (kg)	Référence
	Latéral (q x d)	Face (q x d)	Latéral (q x d)	Face (q x d)		
89	-	4x10	8x13	5x12	4,2	B50089T5105
102	-	4x10	8x14	6x13	5,3	B50102T5105
115	-	4x11	8x15	6x14	6,9	B50115T5105
127	-	4x11	8x15	4x15,4x13	8,2	B50127T5105
152	-	4x12	8x16	4x16,4x15	13,8	B50152T5105
89	-	3x11	9x12	7x11	3,9	B60089T5105
102	-	3x12	9x13	7x12	5,1	B60102T5105
115	-	3x12	9x14	8x13	7,2	B60115T5105
127	-	3x12	9x16	8x15	9,7	B60127T5105
152	-	3x13	9x16	8x15	14,5	B60152T5105
89	-	3x11	9x13	9x11	4,3	B52089T5105
102	-	3x12	9x14	9x12	5,3	B52102T5105
115	-	3x12	9x15	10x13	7,1	B52115T5105
127	-	3x13	9x16	10x14	8,4	B52127T5105
152	-	3x13	9x16	10x15	12,1	B52152T5105
89	-	2x13	8x14	5x13	4,0	B52089T5115
102	-	2x13	8x15	6x14	5,2	B52102T5115
115	-	2x14	8x16	6x15	7,5	B52115T5115
127	-	2x14	8x16	8x15	8,3	B52127T5115
152	-	2x14	8x17	8x16	13,0	B52152T5115

## Taillants :



**Drop Center B51**



**Drop Center B61**



**Face Plate B53**

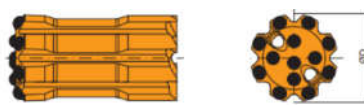

**Heavy Duty B53**

Diamètre (mm)	Trous de soufflage (mm)		Boutons (mm)		Poids (kg)	Référence
	Latéral (q x d)	Face (q x d)	Latéral (q x d)	Face (q x d)		
89	-	4x10	8x13	5x12	5,0	B51089T5105
102	-	4x10	8x14	6x13	7,0	B51102T5105
115	-	4x11	8x15	6x14	9,7	B51115T5105
127	-	4x11	8x15	4x15,4x13	12,7	B51127T5105
152	-	4x12	8x16	4x16,4x15	19,0	B51152T5105
89	-	3x11	9x12	7x11	3,9	B61089T5105
102	-	3x12	9x13	7x12	7,1	B61102T5105
115	-	3x12	9x14	8x13	10,2	B61115T5105
127	-	3x12	9x16	8x15	13,8	B61127T5105
152	-	3x13	9x16	8x15	15,0	B61152T5105
89	-	3x11	9x13	9x11	4,8	B53089T5105
102	-	3x12	9x14	9x12	6,8	B53102T5105
115	-	3x12	9x15	10x13	9,7	B53115T5105
127	-	3x13	9x16	10x14	12,2	B53127T5105
152	-	3x13	9x16	10x15	19,2	B53152T5105
89	-	2x13	8x14	5x13	5,1	B53089T5115
102	-	2x13	8x15	6x14	6,7	B53102T5115
115	-	2x14	8x16	6x15	10,1	B53115T5115
127	-	2x14	8x16	8x15	11,9	B53127T5115
152	-	2x14	8x17	8x16	15,2	B53152T5115



## Tiges :

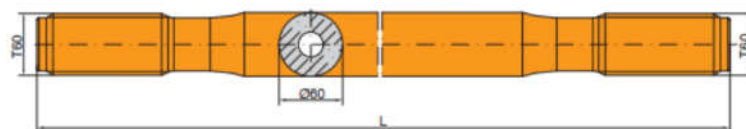

Diam. (mm)	Filetage	Longueur (mm)	Poids (kg)	Référence
60	T60/T60	1830	32,5	10R60T60T60183
60	T60/T60	2435	43,3	10R60T60T60243
60	T60/T60	3050	54,3	10R60T60T60305
60	T60/T60	3660	65,1	10R60T60T60366
60	T60/T60	4265	75,8	10R60T60T60426
60	T60/T60	4915	87,3	10R60T60T60491
60	T60/T60	5470	97,2	10R60T60T60547
60	T60/T60	6100	108,4	10R60T60T60610

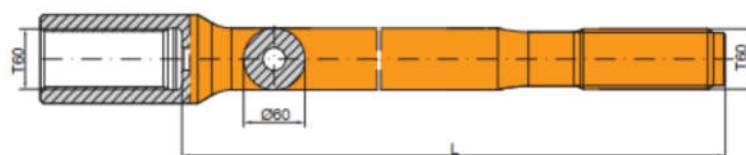

Diam. (mm)	Filetage	Longueur (mm)	Poids (kg)	Référence
60	T60/T60	1830	38,5	11R60T60T60183
60	T60/T60	2435	51,2	11R60T60T60243
60	T60/T60	3050	61,2	11R60T60T60305
60	T60/T60	3660	73,4	11R60T60T60366
60	T60/T60	4265	84,9	11R60T60T60426
60	T60/T60	4915	97,8	11R60T60T60491
60	T60/T60	5470	108,8	11R60T60T60547
60	T60/T60	6100	121,4	11R60T60T60610

T60



## Tiges :

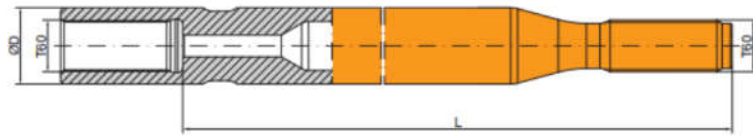

Diam. (mm)	Filetage	Longueur (mm)	Poids (kg)	Référence
87	T60/T60	3660	96,2	1287T60T60366
87	T60/T60	4265	112,1	1287T60T60426

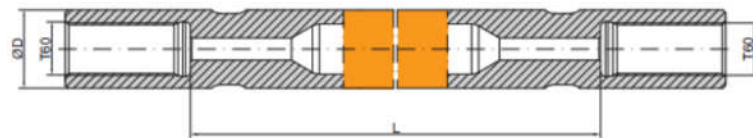

Diam. (mm)	Filetage	Longueur (mm)	Poids (kg)	Référence
87	T60/T60	3660	104,0	1387T60T60366
87	T60/T60	4265	119,0	1387T60T60426



## Manchons :

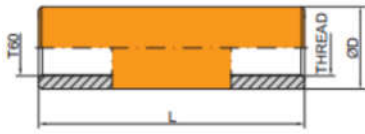

D (mm)	Filetage	L (mm)	Poids (kg)	Référence
85	T60/T51	255	7,3	3985T60T5100
85	T60/T60	260	6,6	3985T60T6000

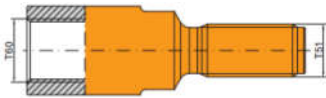

Filetage	L (mm)	Poids (kg)	Référence
T60/T51	270	5,5	3985T60T5103

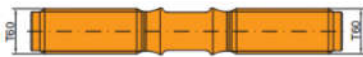

Filetage	L (mm)	Poids (kg)	Référence
T60/T60	350	7,4	3860T60T6000

T60

## Taillants :



Drop Center B50

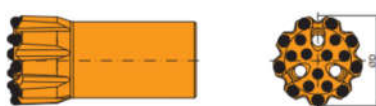

Face Plate B52



Heavy Duty B52

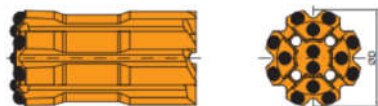

Drop Center B51

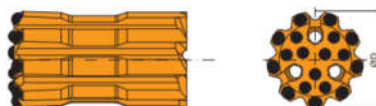

Face Plate B53



Heavy Duty B53

Diamètre (mm)	Trous de soufflage (mm)		Boutons (mm)		Poids (kg)	Référence
	Latéral (q x d)	Face (q x d)	Latéral (q x d)	Face (q x d)		
92	-	4x11	8x14	5x13	5,4	B50092T6005
96	-	4x11	8x14	5x13	5,7	B50096T6005
102	-	4x12	8x14	6x13	6,3	B50102T6005
115	-	4x12	8x15	6x14	7,4	B50115T6005
127	-	4x13	8x15	4x15,4x13	9,2	B50127T6005
140	-	4x14	8x16	4x16,4x15	13,0	B50140T6005
152	-	4x14	8x16	4x16,4x15	15,1	B50152T6005
102	-	3x14	9x14	9x12	6,5	B52102T6005
115	-	3x14	9x15	10x13	7,7	B52115T6005
127	-	3x14	9x16	10x14	10,3	B52127T6005
140	-	3x14	9x16	10x15	13,7	B52140T6005
152	-	3x14	9x16	10x15	15,1	B52152T6005
102	-	2x15	8x15	6x14	5,9	B52102T6015
115	-	2x16	8x16	6x15	8,0	B52115T6015
127	-	2x16	8x16	8x15	11,2	B52127T6015
140	-	2x17	8x17	8x16	13,7	B52140T6015
152	-	2x17	8x17	8x16	15,1	B52152T6015
92	-	4x11	8x14	5x13	5,5	B51092T6005
96	-	4x11	8x14	5x13	6,2	B51096T6005
102	-	4x12	8x14	6x13	7,6	B51102T6005
115	-	4x12	8x15	6x14	10,1	B51115T6005
127	-	4x13	8x15	4x15,4x13	12,7	B51127T6005
140	-	4x14	8x16	4x16,4x15	15,8	B51140T6005
152	-	4x14	8x16	4x16,4x15	19,4	B51152T6005
102	-	3x14	9x14	9x12	7,5	B53102T6005
115	-	3x14	9x15	10x13	8,7	B53115T6005
127	-	3x14	9x16	10x14	13,5	B53127T6005
140	-	3x14	9x16	10x15	15,7	B53140T6005
152	-	3x14	9x16	10x15	19,1	B53152T6005
102	-	2x15	8x15	6x14	7,0	B53102T6015
115	-	2x16	8x16	6x15	8,4	B53115T6015
127	-	2x16	8x16	8x15	12,3	B53127T6015
140	-	2x17	8x17	8x16	15,1	B53140T6015
152	-	2x17	8x17	8x16	18,4	B53152T6015



## Tiges :

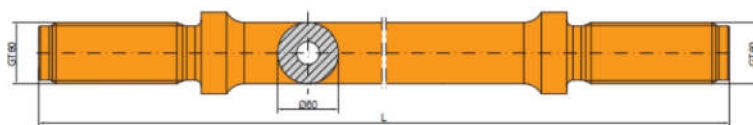

Diam. (mm)	Filetage	Longueur (mm)	Poids (kg)	Référence
60	GT60/GT60	1830	35,8	10R60G60G60183
60	GT60/GT60	2435	47,5	10R60G60G60243
60	GT60/GT60	3050	58,7	10R60G60G60305
60	GT60/GT60	3660	70,6	10R60G60G60366
60	GT60/GT60	4265	82,2	10R60G60G60426
60	GT60/GT60	4915	94,6	10R60G60G60491
60	GT60/GT60	5470	105,3	10R60G60G60547
60	GT60/GT60	6100	117,5	10R60G60G60610

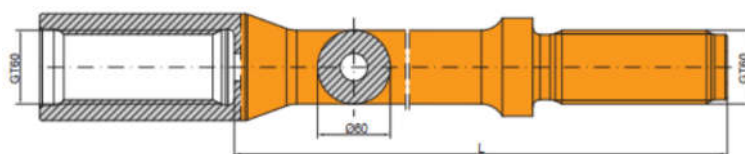

Diam. (mm)	Filetage	Longueur (mm)	Poids (kg)	Référence
60	GT60/GT60	1830	40,5	11R60G60G60183
60	GT60/GT60	2435	53,6	11R60G60G60243
60	GT60/GT60	3050	62,7	11R60G60G60305
60	GT60/GT60	3660	75,4	11R60G60G60366
60	GT60/GT60	4265	86,9	11R60G60G60426
60	GT60/GT60	4915	99,1	11R60G60G60491
60	GT60/GT60	5470	110,4	11R60G60G60547
60	GT60/GT60	6100	121,5	11R60G60G60610

## Tiges :

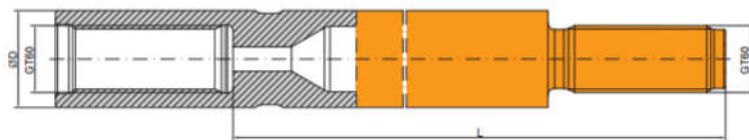

Diam. (mm)	Filetage	Longueur (mm)	Poids (kg)	Référence
87	GT60/GT60	3660	97,8	1287G60G60366
87	GT60/GT60	4265	113,0	1287G60G60426

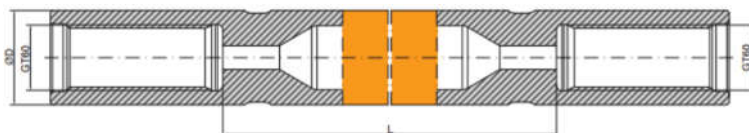

Diam. (mm)	Filetage	Longueur (mm)	Poids (kg)	Référence
87	GT60/GT60	3660	105,0	1387G60G60366
87	GT60/GT60	4265	120,0	1387G60G60426



## Manchons :

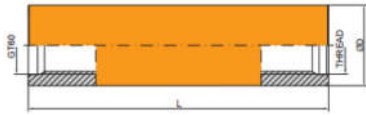

D (mm)	Filetage	L (mm)	Poids (kg)	Référence
85	GT60/T51	285	8,2	3985G60T5100
85	GT60/GT60	320	8,1	3985G60G6000

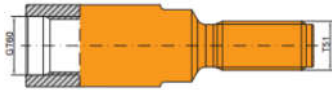

Filetage	L (mm)	Poids (kg)	Référence
GT60/T51	300	6,1	3985G60T5103

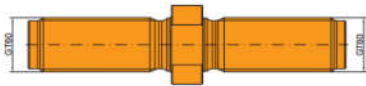

Filetage	L (mm)	Poids (kg)	Référence
GT60/GT60	355	7,5	3860G60G6000

## Taillants :



Drop Center B50

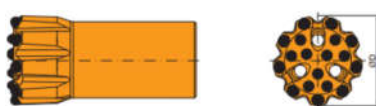

Face Plate B52



Heavy Duty B52

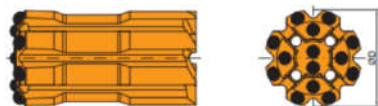

Drop Center B51

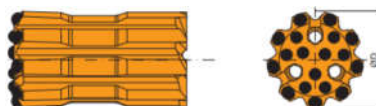

Face Plate B53

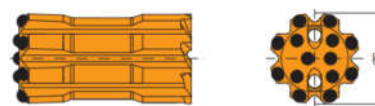

Heavy Duty B53

Diamètre (mm)	Trous de soufflage (mm)		Boutons (mm)		Poids (kg)	Référence
	Latéral (q x d)	Face (q x d)	Latéral (q x d)	Face (q x d)		
92	-	4x11	8x14	5x13	6,1	B50092G6005
96	-	4x11	8x14	5x13	6,4	B50096G6005
102	-	4x12	8x14	6x13	7,0	B50102G6005
115	-	4x12	8x15	6x14	8,3	B50115G6005
127	-	4x13	8x15	4x15,4x13	11,3	B50127G6005
140	-	4x14	8x16	4x16,4x15	14,5	B50140G6005
152	-	4x14	8x16	4x16,4x15	16,6	B50152G6005
102	-	3x14	9x14	9x12	7,2	B52102G6005
115	-	3x14	9x15	10x13	8,5	B52115G6005
127	-	3x14	9x16	10x14	11,5	B52127G6005
140	-	3x14	9x16	10x15	15,2	B52140G6005
152	-	3x14	9x16	10x15	16,6	B52152G6005
102	-	2x15	8x15	6x14	6,6	B52102G6015
115	-	2x16	8x16	6x15	8,8	B52115G6015
127	-	2x16	8x16	8x15	11,9	B52127G6015
140	-	2x17	8x17	8x16	15,2	B52140G6015
152	-	2x17	8x17	8x16	16,6	B52152G6015
92	-	4x11	8x14	5x13	6,0	B51092G6005
96	-	4x11	8x14	5x13	6,8	B51096G6005
102	-	4x12	8x14	6x13	7,7	B51102G6005
115	-	4x12	8x15	6x14	10,9	B51115G6005
127	-	4x13	8x15	4x15,4x13	13,9	B51127G6005
140	-	4x14	8x16	4x16,4x15	17,0	B51140G6005
152	-	4x14	8x16	4x16,4x15	20,9	B51152G6005
102	-	3x14	9x14	9x12	8,1	B53102G6005
115	-	3x14	9x15	10x13	9,5	B53115G6005
127	-	3x14	9x16	10x14	14,4	B53127G6005
140	-	3x14	9x16	10x15	16,9	B53140G6005
152	-	3x14	9x16	10x15	20,7	B53152G6005
102	-	2x15	8x15	6x14	7,8	B53102G6015
115	-	2x16	8x16	6x15	9,7	B53115G6015
127	-	2x16	8x16	8x15	14,0	B53127G6015
140	-	2x17	8x17	8x16	16,9	B53140G6015
152	-	2x17	8x17	8x16	20,7	B53152G6015



# MCEP DISTRIBUTION



Forage



Minage



Attaque au sol et matériel d'usure



Nettoyeurs industriels



Produits spécifiques

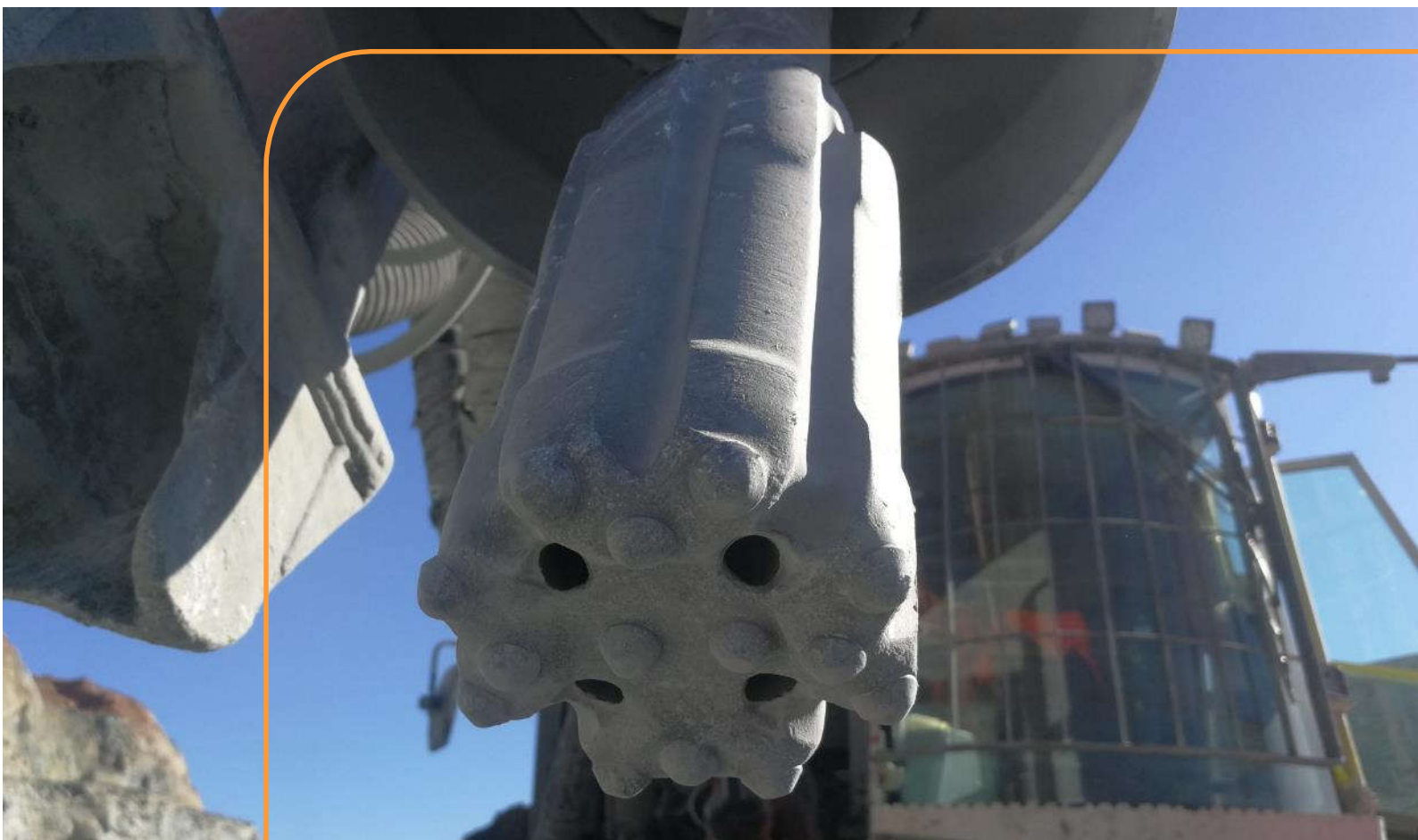

MCEP DISTRIBUTION – 3 rue du Prélot  
25340 L'HOPITAL SAINT-LIEFFROY



[www.mcep-distribution.com](http://www.mcep-distribution.com)



Commercial :	<a href="mailto:commercial@mcep-distribution.com">commercial@mcep-distribution.com</a>	+33 7 71 24 21 58
Technique :	<a href="mailto:eric.petit@mcep-distribution.com">eric.petit@mcep-distribution.com</a>	+33 6 26 49 69 20
Administratif :	<a href="mailto:admin@mcep-distribution.com">admin@mcep-distribution.com</a>	+33 6 48 00 66 08



Société par actions simplifiées au capital de 30 000 € - RCS BESANCON B 807 572 326

L'éditeur se réserve le droit des erreurs d'impression, des changements de lois et règlements et d'éventuelles modification des produits.

© 2024 MCEP DISTRIBUTION